

STAGEMAKER



OWNER'S MANUAL

RIGGER RxSRB CONTROLLERS



TABLE OF CONTENTS

1- INTRODUCTION: Purpose of this guide	4
1.1 Characteristics	4
1.2 Safety instructions	5
1.3 Warranty	7
1.4 CE	8
2 - GENERAL PRESENTATION OF THE SYSTEM	9
2.1- General operating conditions	9
2.2 - Routine maintenance and repairs	9
2.3 Preventive maintenance	10
3-BASIC PRINCIPLE OF OPERATION	10
3.1- Light signalling (Figure 1)	10
Presence of control voltage	10
3.3- Connections	11
3.4- Operating the controller	12
Starting up	12
3.5 Operating	13
4- OPTIONS	14
4.1- Remote control with button box:	14
4.2- HF remote control with RAD32 option	15
4.3- Load cell	

APPENDICES

Wiring diagrams
Examples of uses
Dimensional data
List of parts

Purpose of this guide

The purpose of this guide is to accurately describe the operation of the system from the user's point of view.

It firstly sets out the general operation of the system then details the hardware and software.

1- INTRODUCTION

STAGEMAKER® CONTROLLER was specifically developed to control VERLINDE STAGEMAKER® SR series electric chain hoist. Controllers are available with 4, 8 or 12 channels; they fit into a 19" rack flight case.

For more extensive applications, STAGEMAKER® CONTROLLERS can be interconnected to control systems integrating 16 motors or even more. The standard system provides for the simultaneous activation of all the preselected motors by means of the START button. Other interconnections are available on request.

STAGEMAKER® CONTROLLER® fully complies with the most recent European electricity standards (IEC standards / EMC directive) and is approved by APAVE (French inspection authority). They offer great flexibility, toughness and safety.

1.1 Characteristics / Theater controller equipment for type B hoists (Low voltage):

1. System of phase detection and automatic correction for the entire THEATRE range.
2. Standard prewiring, added as an option for offset control by wire or radio, available across the whole THEATRE range.
3. Power supply: 400 / 415 V 3 Phase ~N- 50/60Hz.
4. 5-pole CE 32 A power plug for 4, 8 and 12 channels
5. Hoist output connections by 6-pole CE multi-pin connectors (1 motor per connector)
6. Control voltage 24/48 Vdc
7. Protection against short circuits
8. Thermal protection by groups of 4 motors
9. Master/slave function: 2 or more controllers can be coupled
10. Max. power per channel: 1.8 kW / 400V 3Phases

1.2 Safety instructions - THINGS TO DO:

- Place the controller in a protective cover (if a standard protective cover is not provided).
- Manipulate the controller with the handles located at front or on sides.
- Store the controller in its normal working position sheltered from aggressive environments (dust, humidity, etc).
- Make sure the controller is systematically clean and free from corrosion.
- The installation of the controller must be carried out by a skilled technician.
- Make sure that connecting cables are in good condition and that the connectors are properly installed.
- Make sure connecting cables are always installed symmetrically.
- If the hoist direction does not correspond with Up / Down signals on the controller, check intermediary wiring and change two phases.
- If none of the hoists correspond with signals, change the phases using the inversion device in the CE plug or the reversing switch (careful to cut power beforehand).
- Only use authentic spares to replace parts.
- Always be ready to hit the emergency stop button during operations. All functions shall then be disabled.
- Before starting, make sure that the load is properly secured and installed on the hook. The safety latches must be properly closed.
- Make sure the load is well balanced before moving it.
- Make sure that each hoist is perpendicular with the load and that it hangs freely on its chain before starting any simultaneous action.
- If the system is used in the open air, use adequate guards against inclement weather.
- Operate the equipment under standard working conditions (ambient temperature, environment, etc.).
- The handling of single items or sets of beams must be entrusted to experienced operators.
- Take all necessary precautions to ensure the load is evenly distributed and avoid overloading any single hoist in the case of multiple use. Each hoist must be carefully checked before such use.
- Inform the supervisor of any dangerous functioning or of one which is not reassuring. (Abnormal noise, abnormal behaviour, etc.).

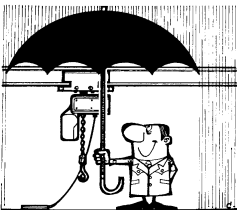

Equipment used in the open air must be protected as much as possible from inclement weather.

THINGS NOT TO DO:

- Never connect a STAGEMAKER controller control unit to any power source other than that indicated on the unit.
- Only set down the controller on an adequate support in order to avoid damaging the components located at the rear.
- Never modify the controller without the maker having first studied and authorized the modification.
- Never modify the settings and adjustments of safety devices beyond the limits set out in the manual or without the maker's authorization.
- Never try to repair or carry out any special operation on the controller without the authorization of the maker or a skilled electrician.
- Never allow any unqualified person to use the controller.
- Never connect a number of hoists greater than the number of available outputs (channels) or the number of available selectors.
- Do not use additional distribution boxes to connect several hoists per channel.
- Avoid shocks or accidental collisions with other objects.
- Never open the controller when the system has power on.
- Never jam or lock the Start button to carry through a manipulation without manual control.
- Do not use the controller if the physical state of the operator will not allow it.
- Never use the controller if it is in bad condition.
- Never use unauthentic spare parts or those suspected of being so.
- Do not allow the controller to receive blows.
- Never distract the operator while he is operating the system.
- Do not use the controller for any function or in any zone for which it is not intended.
- Do not expose the controller to any aggressive environment (temperature, acidity, etc.).
- Do not use safety items as operational items (emergency stop, main fuse, etc.).
- Do not use controls for no useful purpose (avoid very slow movements – repetitive stop-starts with buttons), that can cause overloads or even damage the hoist.
- Do not change the direction of the hoist when the START button is held down (energized hoist)
- If the direction of the hoist does not match the display on the controller, do not modify phases inside the controller but simply change two phases on the hoist motor or on the connection cables.
- Never use hoists that operate in the opposite direction to the selected travel movement.
- Do not connect the controller to any unknown electrical power supply; check that the power supply matches the specifications of the controller and of hoists. (undervoltage or overvoltage +/- 5%, phase failure, etc.).

1.3 Warranty

Our STAGEMAKER controllers are guaranteed for one year as from the delivery date. If a delivery delay were to occur for a reason outside the supplier's control, the said delay period will not exceed three months.

If the operation (installation) of the controller is delayed, an extension of validity corresponding with the warranty period should be requested (one unique extension limited to three months) and written confirmation obtained.

The supplier undertakes to remedy all operating errors resulting from the design or manufacture or from components or materials.

The warranty covers neither normal wear nor failures resulting from abnormal use. Furthermore, it does not cover damage due to a lack of supervision, operating errors or incorrect use of the controller, especially due to an overload, handling movements that are too slow, undervoltage / overvoltage or errors of connection.

The warranty is inapplicable in cases of disassembly, modification or replacement of parts (mechanical or electrical) by a non-authorized person or without our prior agreement. The warranty applies only to original parts assembled in the factory. During the warranty period the supplier undertakes to replace or repair in their workshop, free of charge, parts that are ascertained to be damaged after inspection by a qualified and authorized technical body.

The warranty excludes any other service or any other compensation. Repairs covered by the warranty are generally carried out in the supplier's workshops or in those of an approved agent. When work on equipment takes place outside the said workshops, labour costs for the disassembly or assembly of those parts are borne by the supplier if the operations are carried out exclusively by their personnel or by an approved agent. The replaced parts become the property of the supplier and must be returned to them at their expense.

Relatively important components that are not manufactured by the supplier and that bear the brand of specialist manufacturers are covered by the manufacturer's warranty (variable according to manufacturer).

* The warranty does not apply to consumables defined by the manufacturer:

- Fuses
- Contactor contacts

1.4 Certificate of conformity

We,

VERLINDESAS, 2 bd de l'Industrie, BP 59,
F-28501 VERNOUILLET Cedex, France

declare that the product

STAGEMAKER® CONTROLLER

Serie RIGGER RxSRB

DATE OF MANUFACTURE:

must be used in association with other machines. It cannot be used for as long as the systems in which it is integrated are not declared in compliance with the provisions of directives:

1. Machinery 89/392/EEG (93/68/EEG),
2. Machinery 91/368/EEG,
3. Electrical machinery 73/23/EEG,
4. Electromagnetic compatibility 89/336/EEG

Together with harmonised standards, especially EN292, Chapters 1 and 2 (machinery safety),

Applicable technical standards and specifications, especially:

5. IEC 34-1 "Rotating electrical machines"
6. IEC 34-5 "Rotating electrical machines"
7. IEC 946-5-1 "Low voltage switchgear and control gear"
8. IEC 364 "Electrical installations in buildings"
9. NEN 1010 "Electrical installations"
10. EN 60204 "Electromagnetic compatibility"

The person in charge of integration should recall these phrases in the machine's declaration of compliance, add the regulations and standards when the machine is definitively installed and draft the appropriate technical dossier.

2 -General presentation of the system.

The controller is in the form of a 6U 19" rack, depth 460mm,
Power supply with CE plug P17 5P 32A 400Vac,

On front:

- Signalling lights,
- Emergency stop
- Hoist control 3-position reversing switches with lights
- START button
- Two handles

On rear side:

- Phase rotation relays
- Phase failure relay
- Line circuit breaker
- LV circuit breakers
- Motor circuit breakers (for R8SRB and R12SRB only)
- Remote control connector
- Hoist connector(s)
- Signal lights fuse holder
- Connection plug to another controller
- Load cell contact connector option

2.1 General operating conditions

Only authorized and skilled persons for the control of hoists are allowed to operate the controller.

The controller does not check hoist travel; the user must, without fail, visually supervise all hoists.

They must make sure:

- Hoists are in good condition and serviceable,
- They can visually check the travel of all hoists,
- There are no persons under hoists or under structures/assemblies raised by hoists.

They must check:

- The compatibility of the power supply with that of the controller,
- Electrical connections,
- The condition of power supply and hoist connection cables,

Operating temperature: -5/+45°C

Storage temperature: -30/+80°C

hygrometry: less than 85% RH.

2.2 - Routine maintenance and repairs

The controller must be looked over and repaired using approved procedures, carried out only by authorized companies or by the manufacturer.

Any assembly or disassembly work is prohibited with power on.

Electrical connections must only be made or broken with power down by unplugging the power plug.

2.3 Preventive maintenance

- The maintenance team shall carry out on an annual basis the following operations:
 - Cleaning of the controller,
 - Verification of the general condition of the controller
 - Verification of the emergency stop button.
 - The maintenance team shall carry out the following operations:
 - Switch off the system completely,
 - Unplug all connectors connected to the controller, then proceed with cleaning and verification of the general condition:
 - Gently apply compressed air (dry, oil-free air) inside the controller to remove dust that has gathered.
- CAREFUL: you could damage electrical connections if the compressed air pressure is too great,...
- Check that accessible electrical connections are properly tightened,
 - Check that there are no visible anomalies (overheated, blackened components, leads or connections), or abnormal noise.

3-Basic principle of operation

The controller controls the upward and downward travel of hoists and stop. When at stop the absence of voltage causes the brake to close. Movement will only take place for as long as the Start button is held down.

3.1- Light signalling (Figure 1)

- 1) Presence of control voltage
- 2) Connection of remote control
By wire or HF
- 3) Phase failure
- 4) Power inverting



Figure 1

3.3- Connections

Figure 2

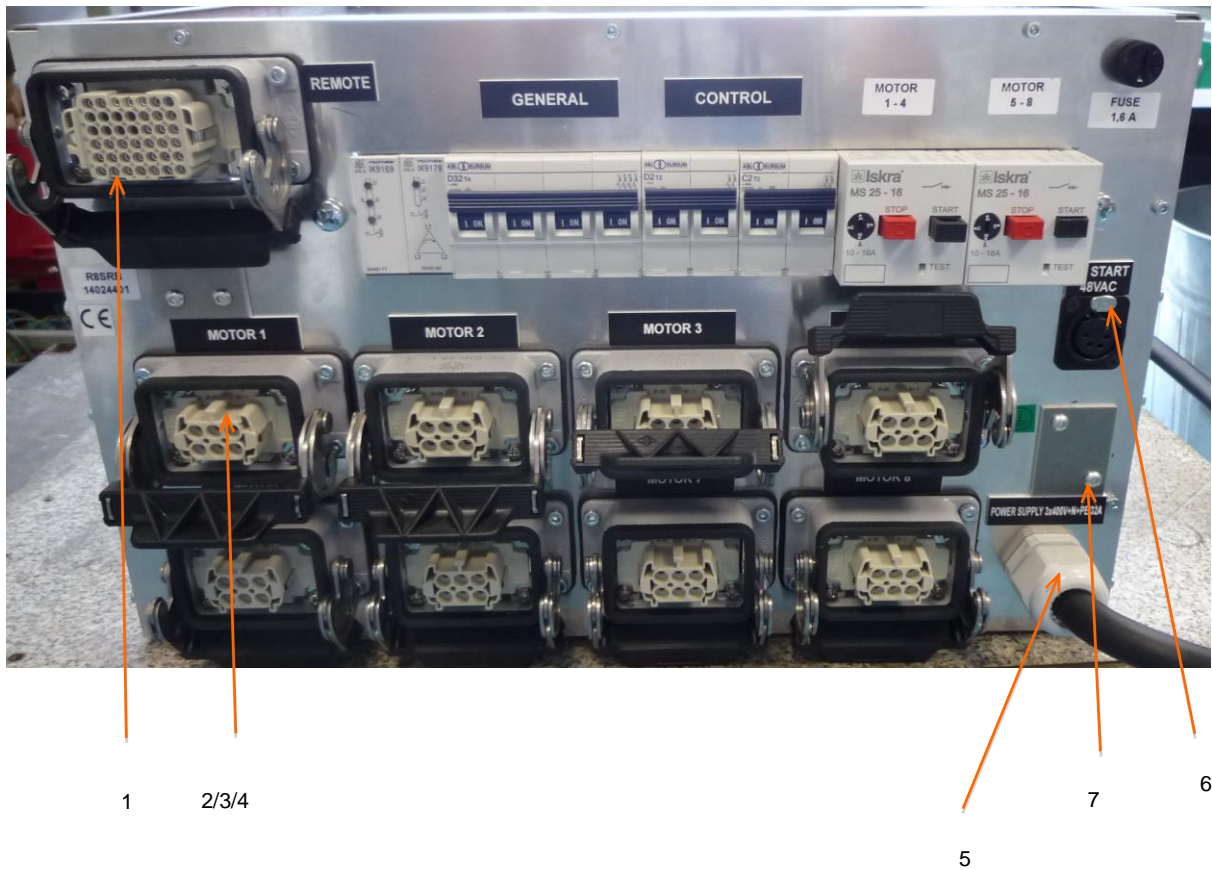

Figure 2

- 1) Connector button box option
- 2) Connector hoists 1 to 4
- 3) Connector hoists 5 to 8 (depending on number of controller channels).
- 4) Connector hoists 9 to 12 (depending on number of controller channels).
- 5) Power cable with plug P17 5P 32A 400V.
- 6) XLR 4-pin socket connector for parallel use with a second controller.
- 7) XLR 3-pin socket connector for load sensor input.

3.4- Operating the controller

Starting up

You must, without fail, comply with start-up instructions to avoid damaging the equipment.

- Connect hoists to the controller
- Connect the power plug,
- Reset all circuit breakers (line, controller and motor)
- Pull the emergency stop into operating position,
- Check the condition of following indicator lights: phase presence, phase rotation, control voltage,
- Correct if necessary depending on condition of lights,
- With all the hoist control reversing switches in position 0, press START and listen for the line contactor to open and close (sound of contactor). If that does not occur check the emergency stop(s) and if it still does not function contact your agent.

Figure 3:

- 1) Phase presence relays – each lighted indicator represents a phase
- 2) Phase rotation relays – the lighted indicator indicates the correct phase sequence
- 3) General circuit breaker
- 4 & 5) Control circuit breakers
- 6,7) Motor circuit breakers, 1 circuit breaker for 4 hoists; the setting of the current depends on the consumption of your hoists. The setting must be made by a skilled person.
- 8) Fuses protecting the led indicators (5x20 1AT)

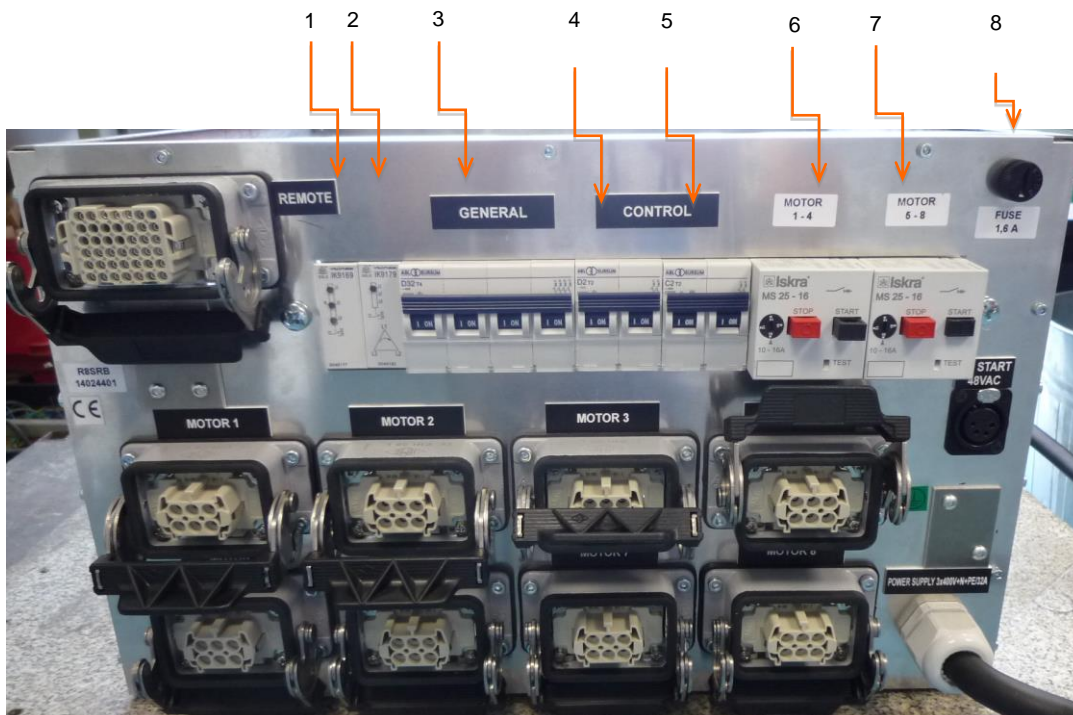

Figure 3

3.5 Operating

On front: FIGURE 4

- 1- Select the operating mode of each hoist with the 3-position reversing switches (1).
 Central position: the hoist is not controlled
 UP position: UP travel is selected
 DOWN position: DOWN travel is selected

- 2- Pull the emergency stop reset button (4)

- 3- Start travel movement(s).

Press Start PB (2), start hoist travel depending on selection of reversing switches (1) while the start PB is held down all the time.

Careful: the controller has no means of checking travel direction of hoists, only the operator can supervise the operation visually. He is responsible for handling operations;

Observation: when a controller power phase is inverted, indicator (3) lights up; the controller is operating correctly as it is fitted with an automatic power inverting system for the equipment.

- 4- Stopping the equipment.

Travel stops when the Start PB is released.

When the system stops you are advised to activate the emergency stop or even disconnect the controller.



Figure 4

4- Options

4.1- Remote control with button box:

Connection: To Connector (1) on figure 2 labelled "REMOTE"

It operates in the same way as for the front.

The connector connection of the remote control automatically commutates the controller to remote control mode; the "REMOTE" light (2) on figure 1 lights up. The reversing switches at front become inoperative.

The two emergency stops on the front and on the remote control have the same function (push-pull Stop Mushroom). Pressure on one of them cuts off power to the hoists. Both must be pulled out again to enable hoist travel.



4.2- HF remote control with RAD32 option

Radio transmission cut-out button. Careful. This does not under any circumstances whatsoever replace the controller emergency stop.

THE CONTROLLER EMERGENCY STOP MUST BE RAPIDLY ACCESSIBLE BY THE OPERATOR

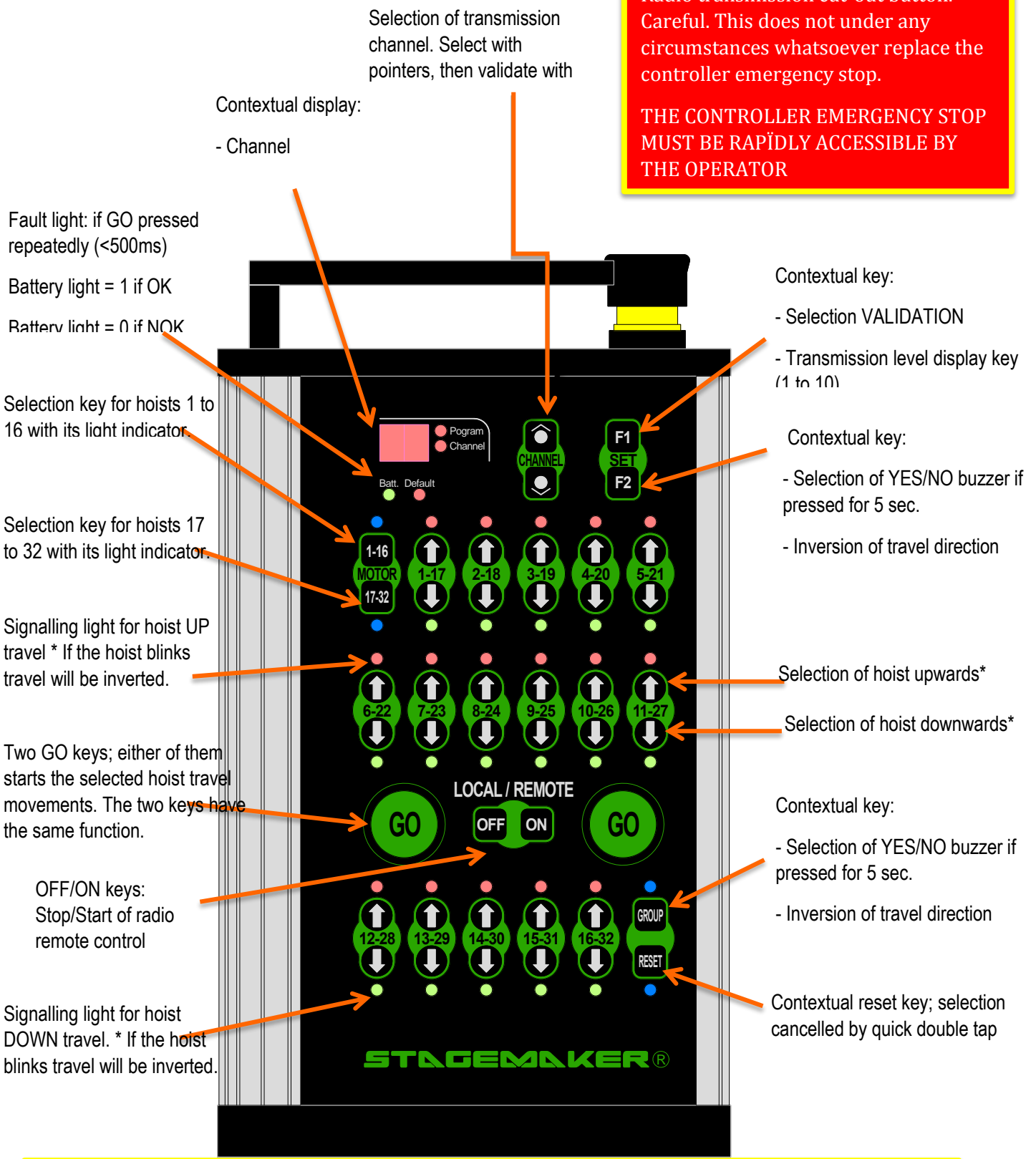

Careful. Check that other radio controllers are not operated on same channel to avoid controlling other hoists

4.2.1 GROUP

CREATION OF A GROUP

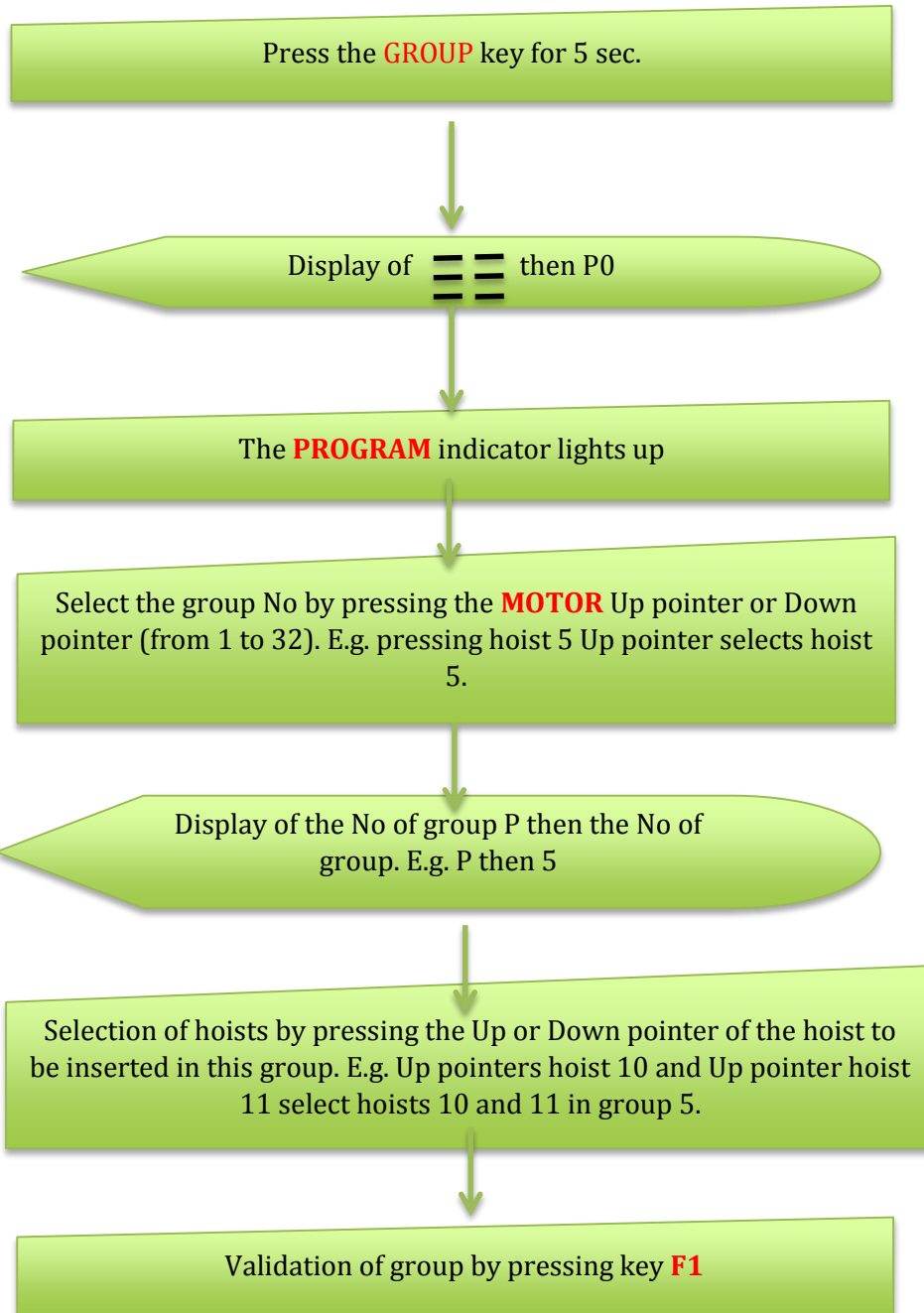

DELETION OF A GROUP

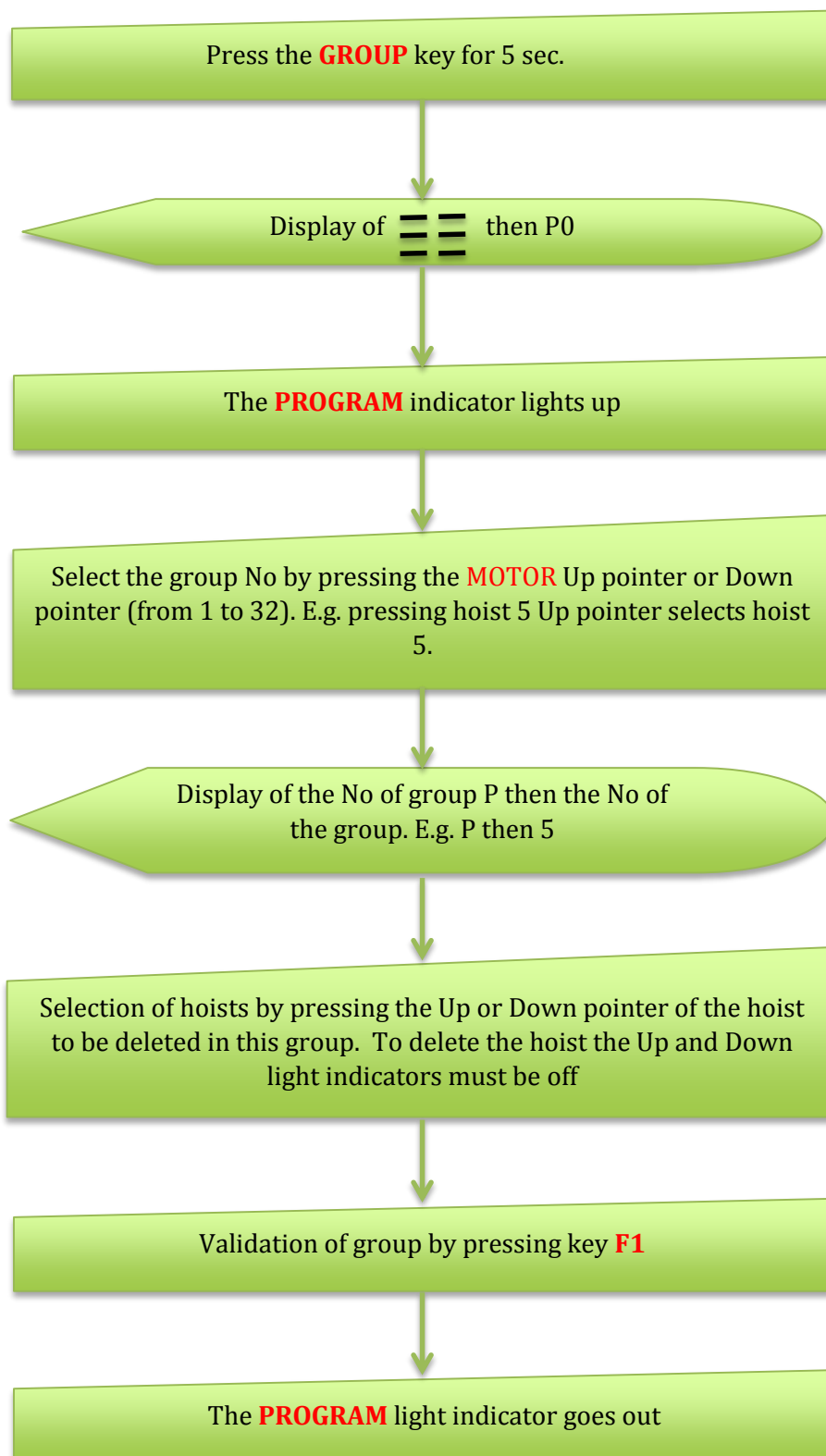

DELETION OF ALL GROUPS

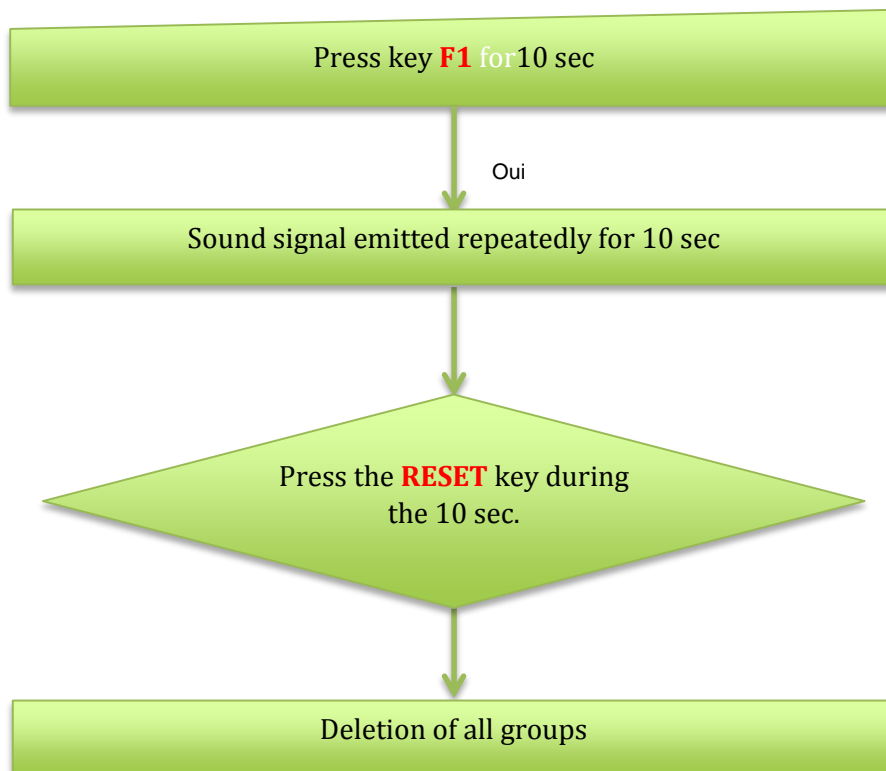

REVERSAL OF DIRECTION OF TRAVEL PER HOIST

If reversal occurs in the direction of travel required on one of the hoists you can remedy the fault without modifying hoist wiring.

This method does not remedy the physical inversion of the wiring but enables a rapid solution to the problem.

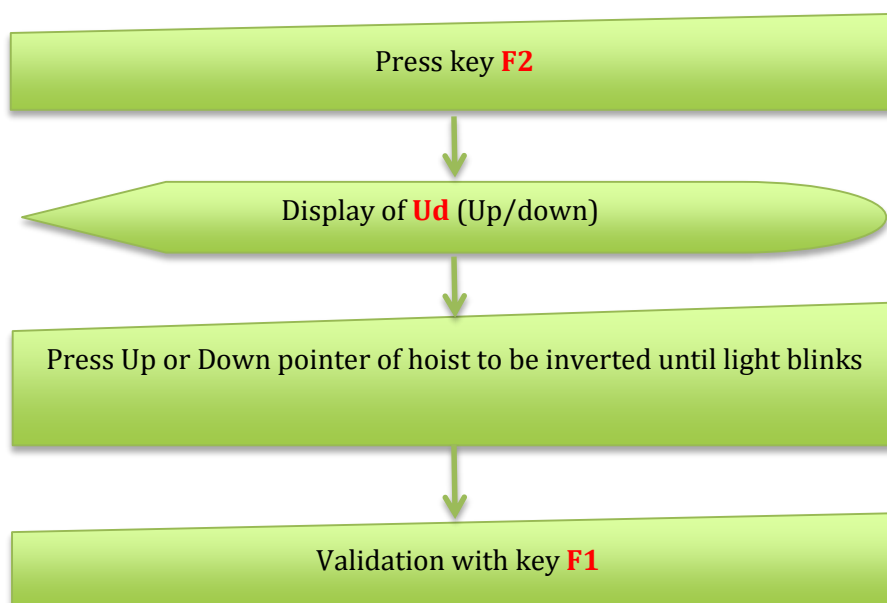

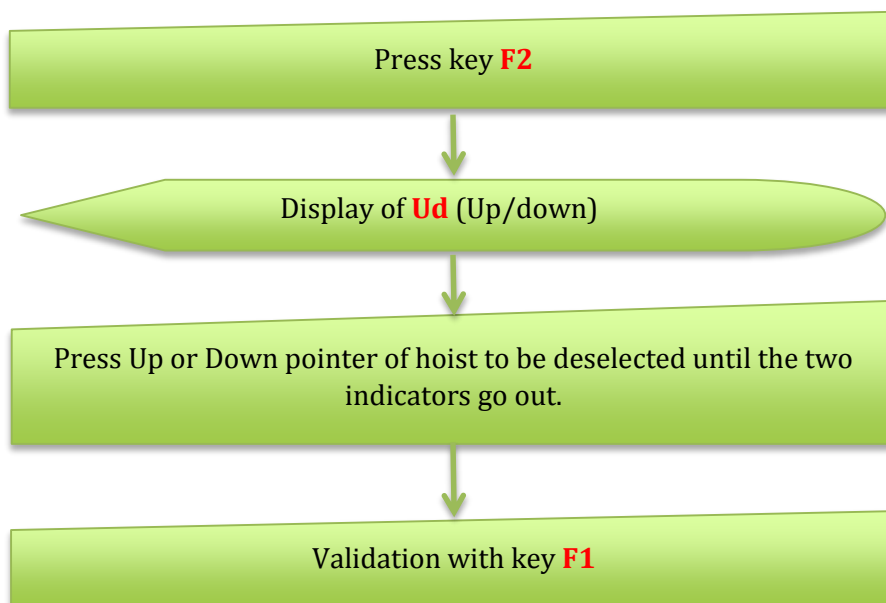
CANCELLATION OF INVERSION.**READING AND/OR CHANGE OF CHANNEL**

To read the **Channel** number, press one of the two **Channel** keys

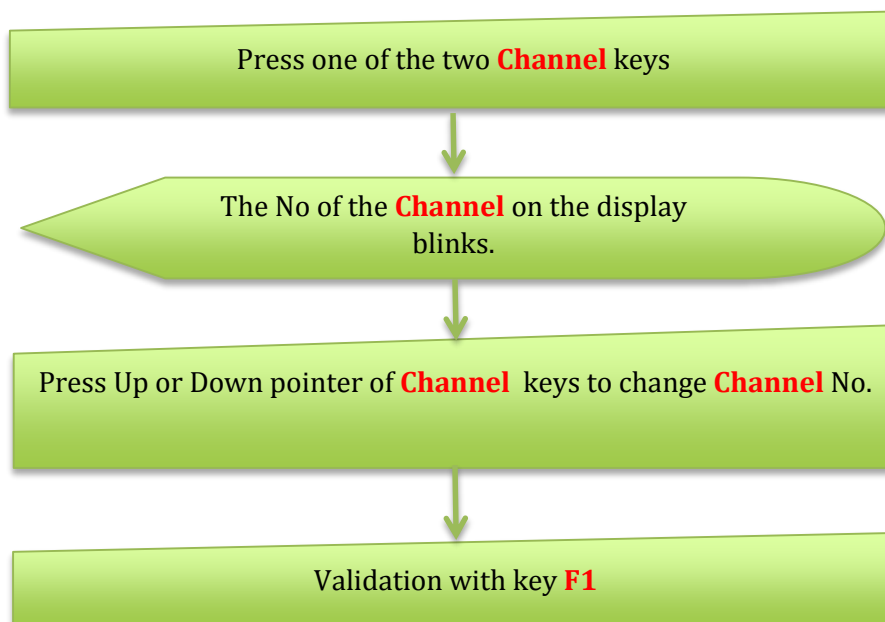

The Channel number must be identical on the transmitter and the receiver.

4.2.2 Hoist control

Definitions:

Operating by group: This mode enables several hoists to be controlled simultaneously. When you press the UP or DOWN pointer of one of the hoists in the group all the hoists in the group will automatically be selected. It is not obligatory that all the hoists are selected without the same direction of travel.

OFF/ON keys: Switches the remote control on and off. When switched on, the readout displays 1-page mode (1P) or 2-page mode (2P) then the last selected group. The remote control being used automatically goes into standby after 30 seconds if there is no action from keypad.

Reset key: a quick double-tap (<0.2 Sec) cancels current selections.

GO keys: Pressing one of the two GO keys starts the selected hoist travel movements.

Group 0: Group 0 is the one where all the motors are independent. To have access, press the GROUP key and then key 1-16.

Hoist control:

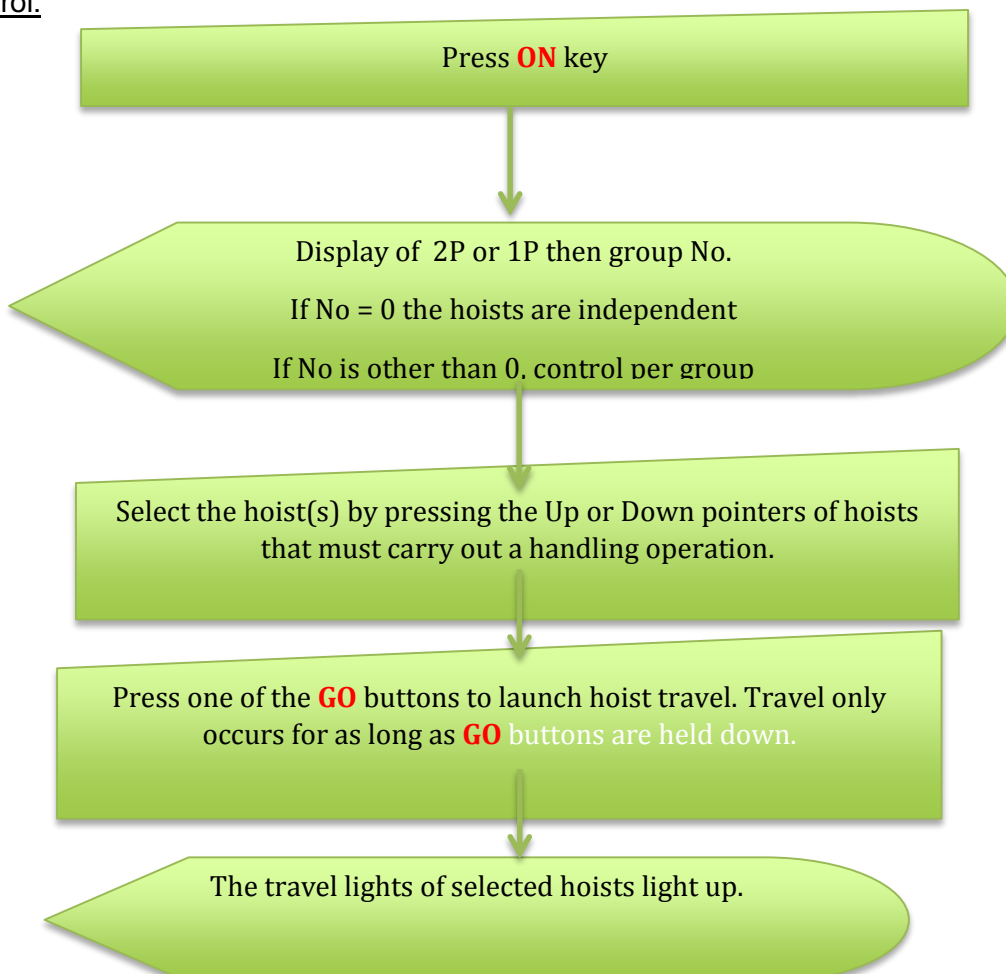

4.2.3 RADIO RECEIVER

Each type of receiver corresponds with only one type of receiver; check that products match.

RHR4A	↔	R4SRA
RHR8A	↔	R8SRA
RHR12A	↔	R12SRA
RHR4B	↔	R4SRB
RHR8B	↔	R8SRB
RHR12B	↔	R12SRB

4.2.4 RADIO RECEIVER CONNECTION

- Switch off power to controller
- Connect the mobile radio receiver connector to the controller's "REMOTE" connector.
- Switch on the controller
- The radio receiver "POWER" light indicator lights up



No of first hoist of controller

Example:

- Operation of an 8-hoist controller and a 12-hoist controller.
- Selection of the first hoist No on controller 8 = 1
- Selection of the first hoist No on controller 12 = 9



Channel selection: The channel must be identical to the radio transmitter channel.

RESET pushbutton after a TR/REC fault at front

4.3- Load cell – Connector option for Setpoint:

This digital input (potential free) connected to the STAGEMAKER RADIO LOAD CELL setpoint enables or disables hoist travel.

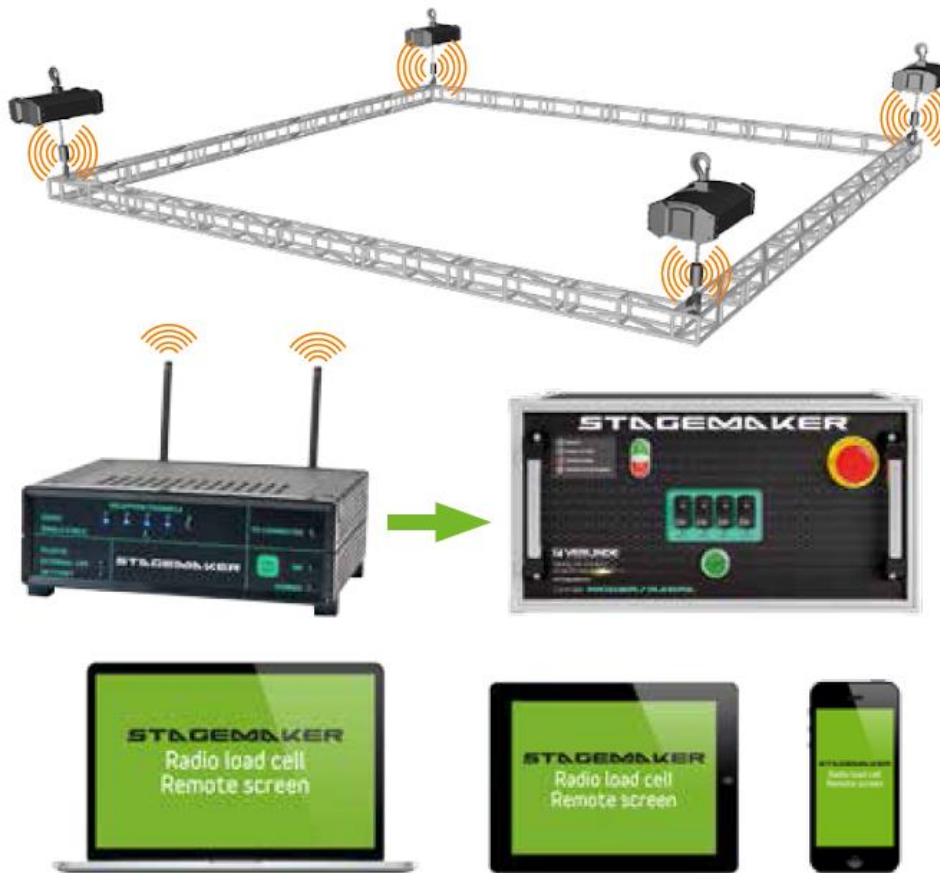

APPENDIX: Electrical diagrams

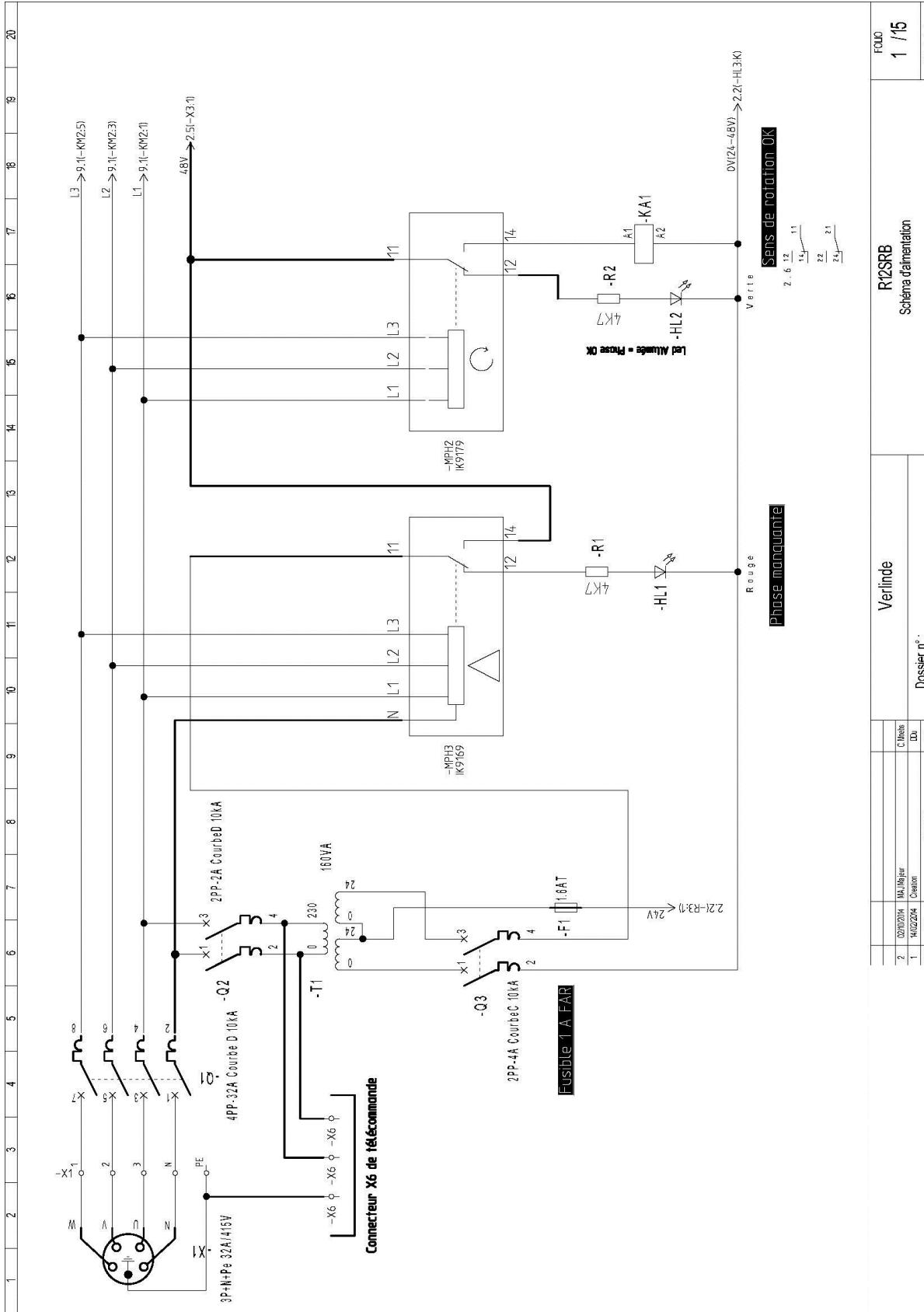

Verlinde		R12SRB		FOUO	
Dossier n° :		Schéma d'alimentation		1 / 15	
2	02/07/2014	Ma. Rajar	C. Denis		
1	14/02/2014	Cherouf	DU		
RDSE	23/E	RDSE/05/01	23/E		

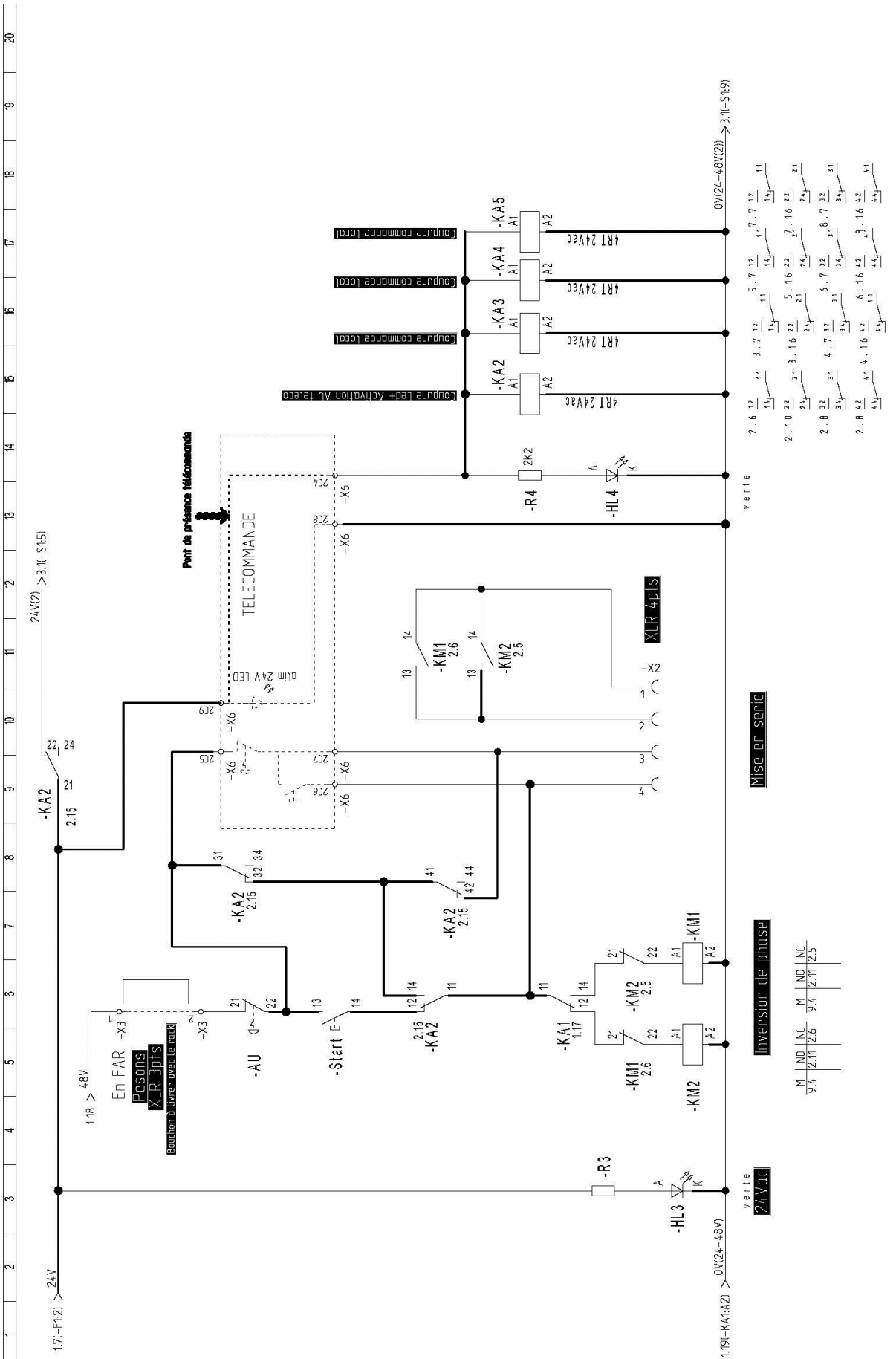

Verlende		R12SRB		F000	
Dossier n° :		Schéma de commande		2 / 15	
1	M02204	Carton			
POSE	3°E	DEL	DEL		

VERLINDE se réserve le droit de modifier sans préavis les caractéristiques de son matériel
 VERLINDE reserves the right to alter or amend specifications of its products without notice

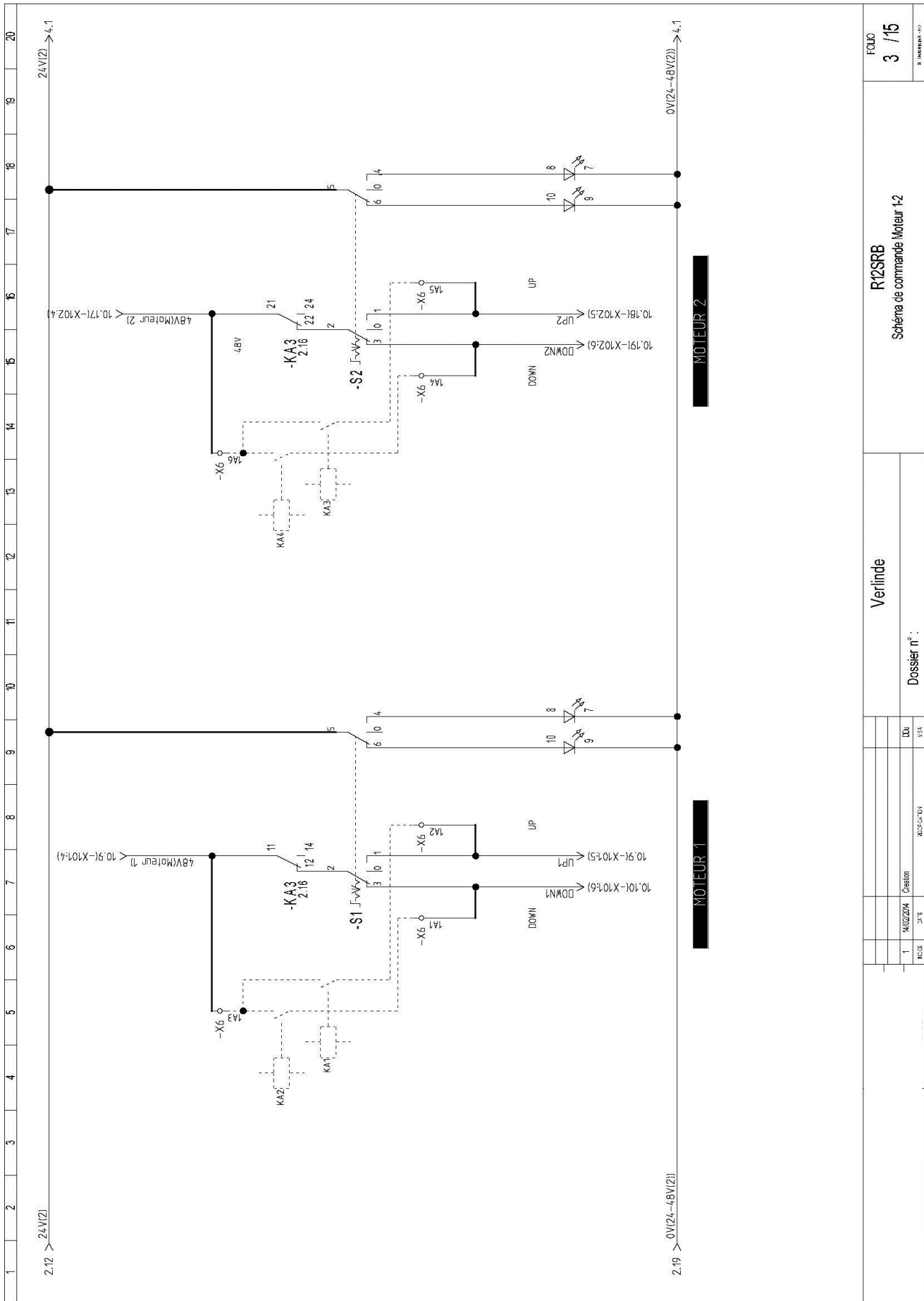

Verlinde		R12SRB		FOUC	
Dossier n° :		Schéma de commande Moteur 1-2		3 / 15	
1	14/02/2014	Creation	MODELE/DN	VER	R INVENTAIRE
NOE	DATE				

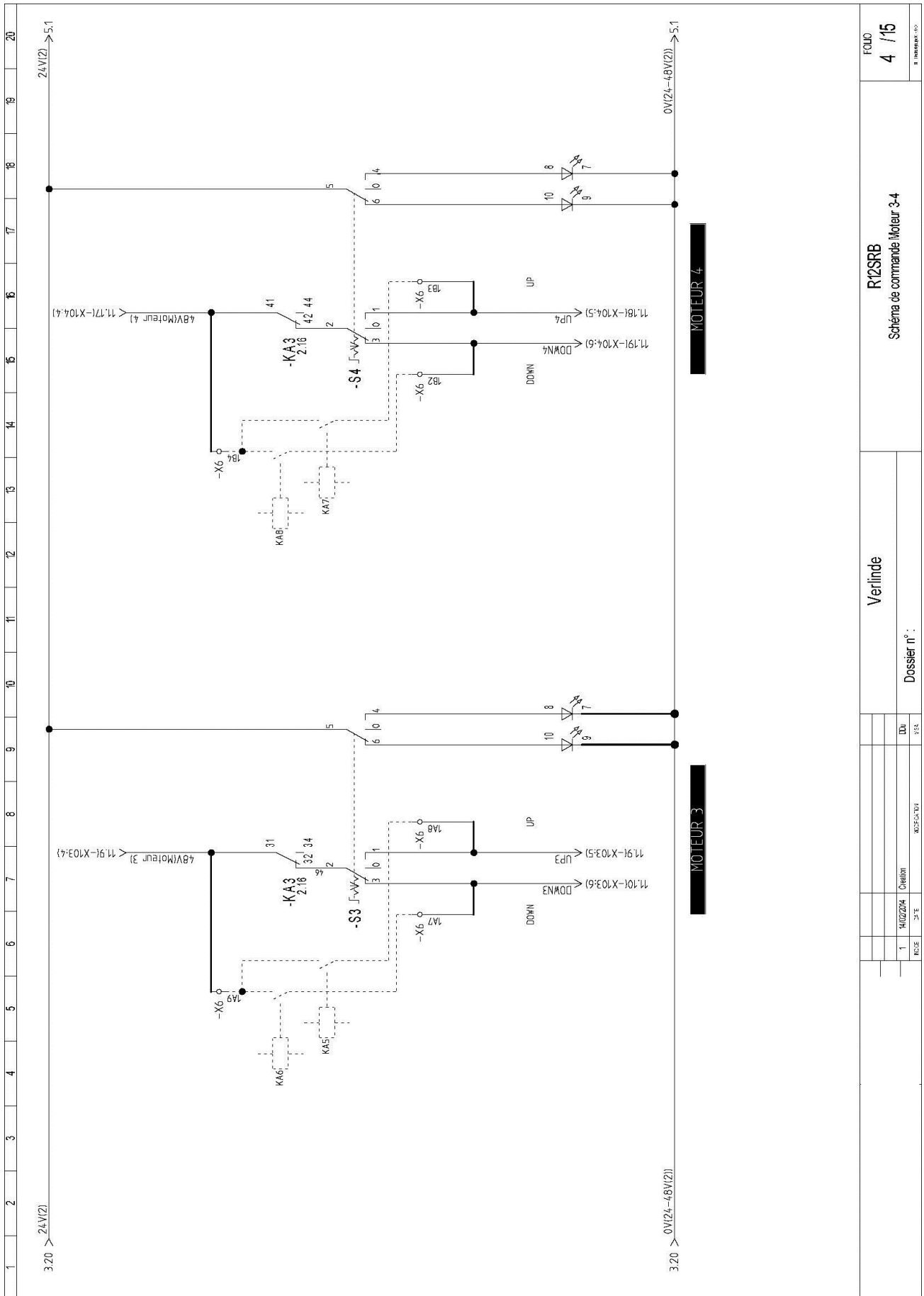

Verlinde		R12SRB		FOUO	
Dossier n° :		Schéma de commande Moteur 3-4		4 / 15	
INDICE	DATE	CHANGEMENT	DDU	S. LINDENBERG 005	
1	14/02/2014	Création	VER		
MOTIF-001					

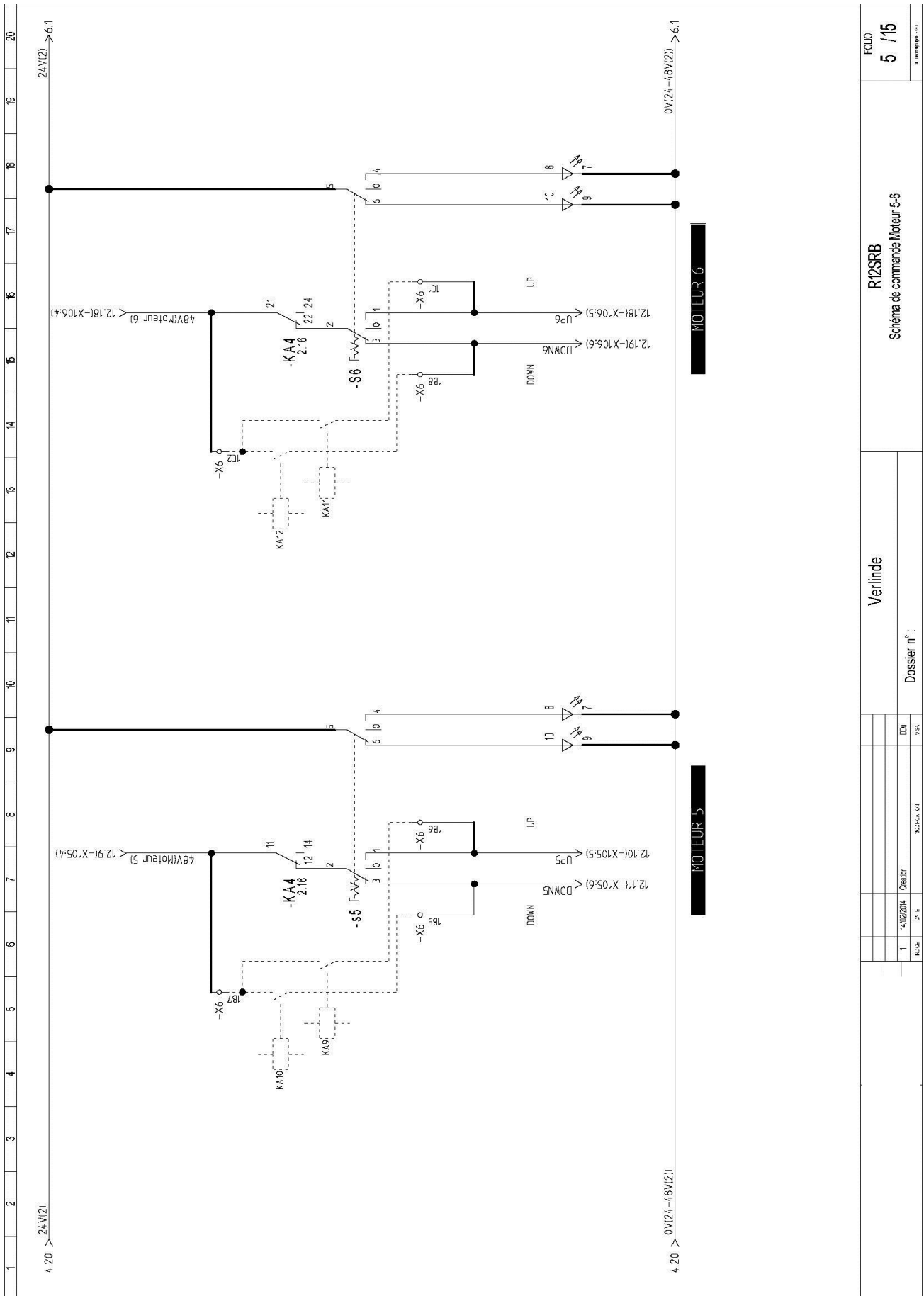

FOUO		5 / 15	
R12SRB		Schéma de commande Moteur 5-6	
Verlinde		Dossier n° :	
1	14/02/2014	0001	001
DATE	DESIGNER	DATE	DESIGNER

VERLINDE se réserve le droit de modifier sans préavis les caractéristiques de son matériel
 VERLINDE reserves the right to alter or amend specifications of its products without notice

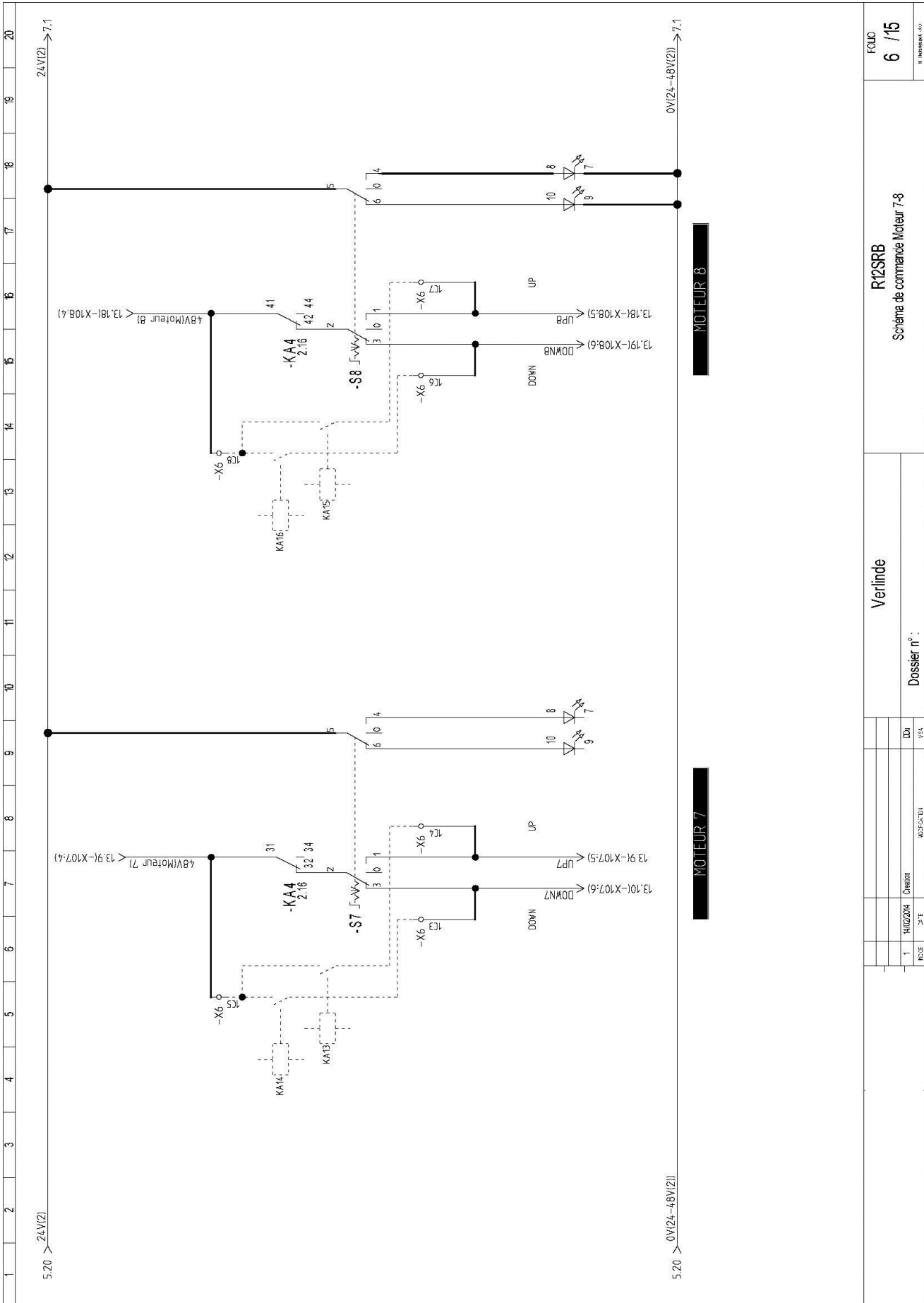

MOTEUR 8

MOTEUR 7

Verlinde		R12SRB		FCUO	
Dossier n° :		Schéma de commande Moteur 7-8		6 / 15	
1	14/02/2014	Creation	13.181-X108.4)	13.181-X108.5)	13.191-X108.6)
1	14/02/2014	Creation	13.181-X107.4)	13.181-X107.5)	13.191-X107.6)
1	14/02/2014	Creation	13.181-X107.4)	13.181-X107.5)	13.191-X107.6)

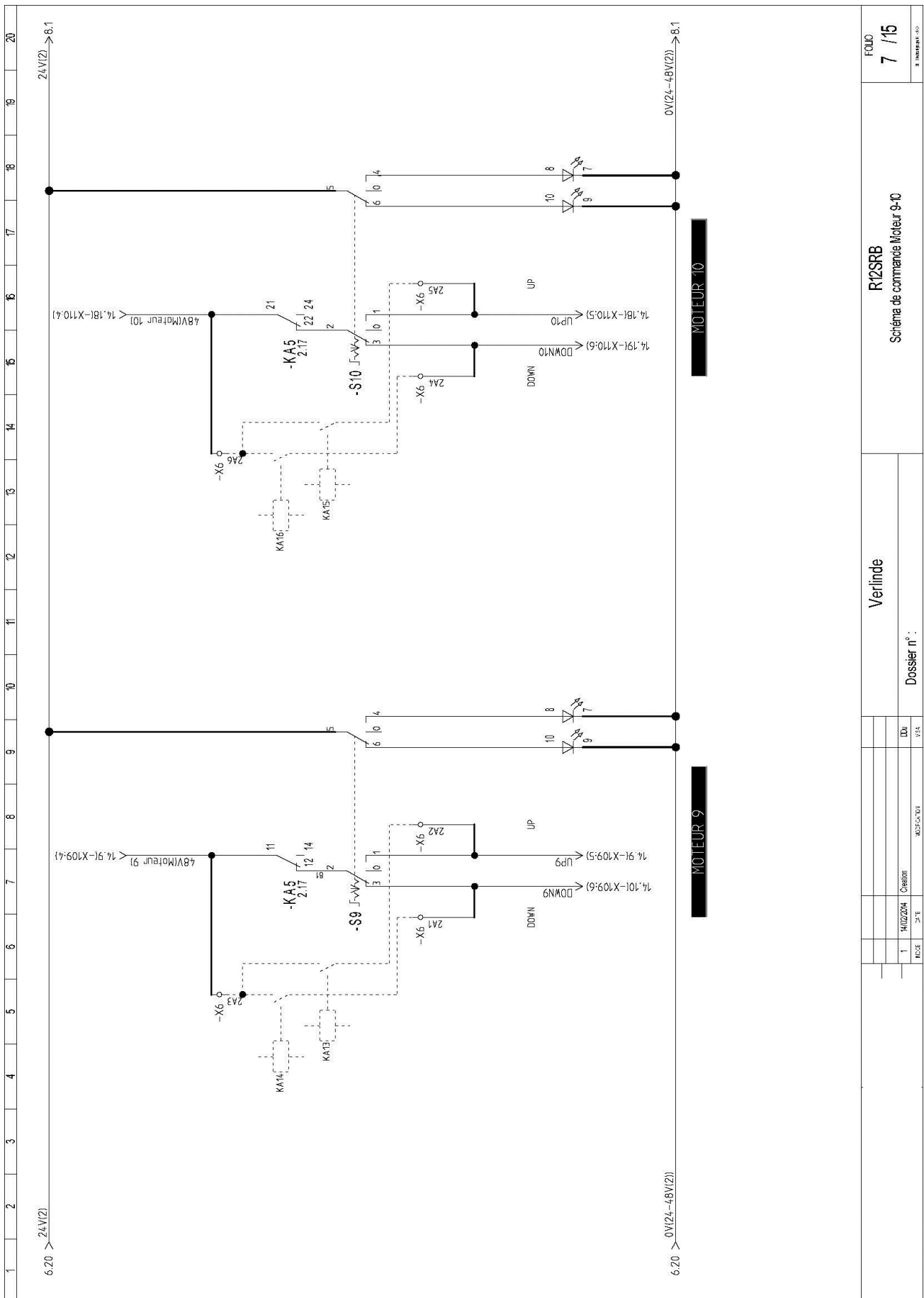

FOUO		7 / 15	
Verlinde		Schéma de commande Moteur 9-10	
Dossier n° :		R12SRB	
DATE	REVISION	DES	DES
1	14/02/2014	0	0
1		0	

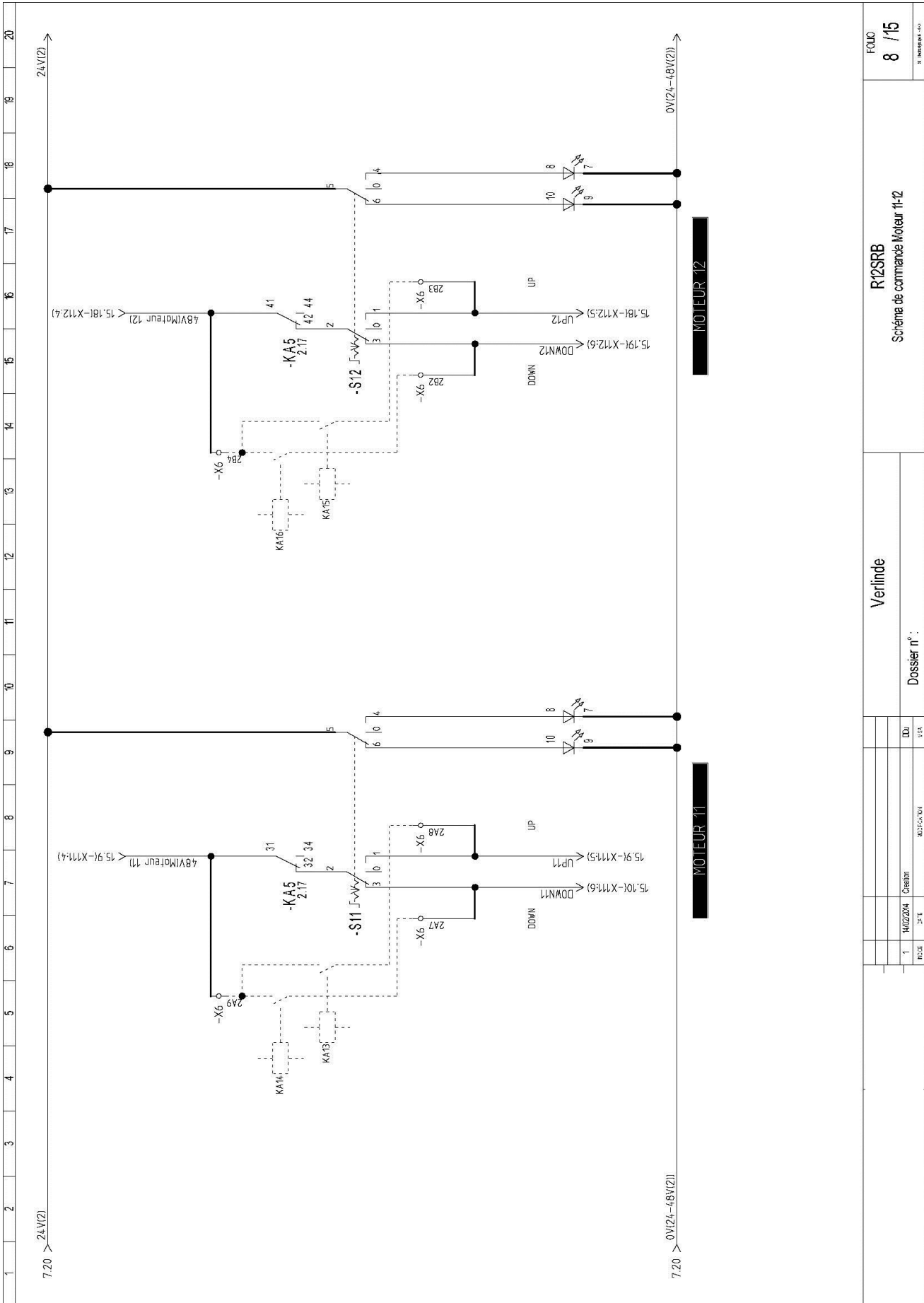

Verlinde		R12SRB		FOUO	
Dossier n° :		Schéma de commande Moteur 11-12		8 /15	
RESE	DATE	MODE/CO/DTI	VER	R INVENTER-00	
1	14/02/2014	Creation	DU		

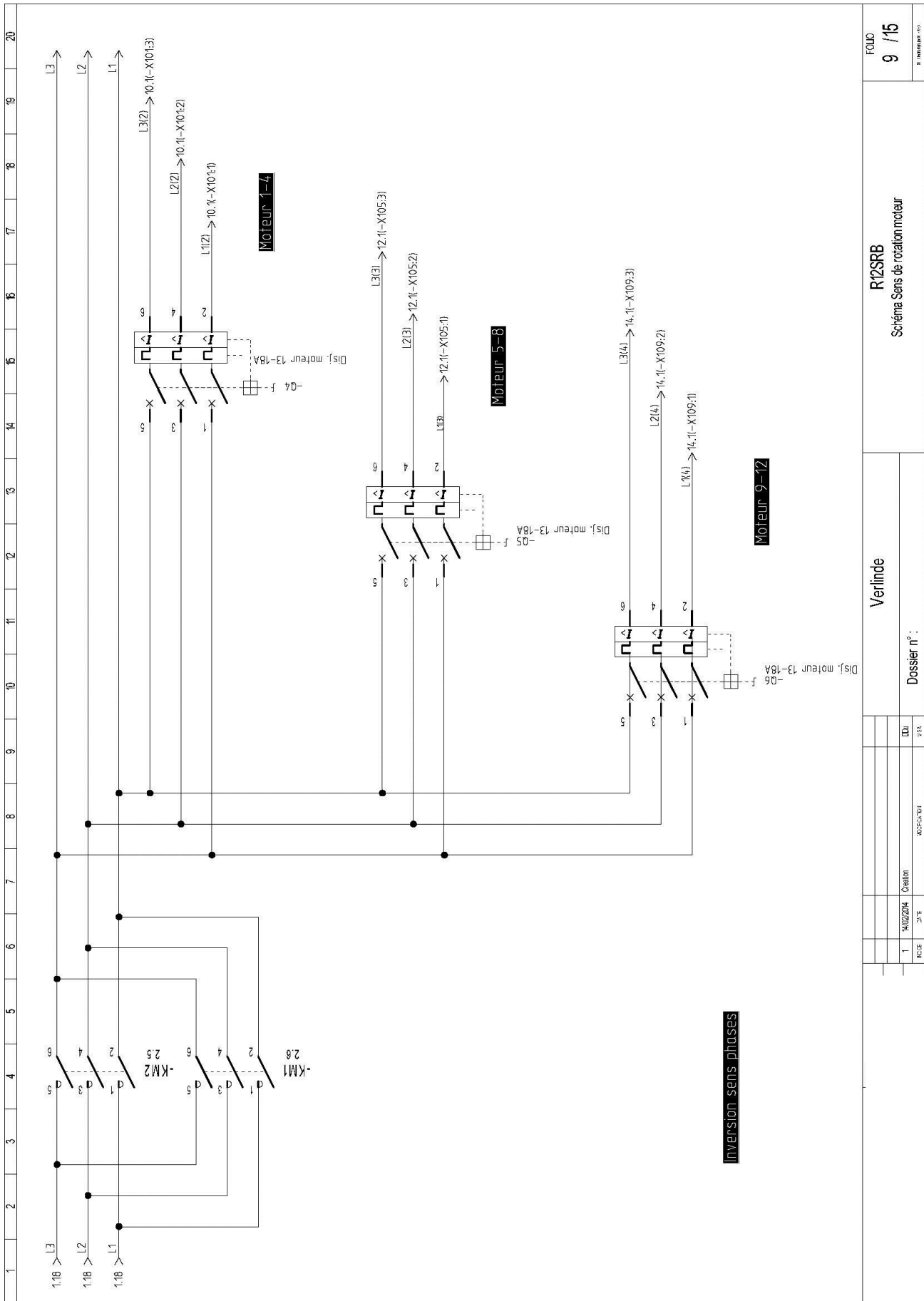

FCO
9 / 15

R12SRB
Schéma Sens de rotation moteur

Verlinde

Dossier n°:

NOE	DATE	Creation	MODIFICATION	DES
1		14/02/2014		

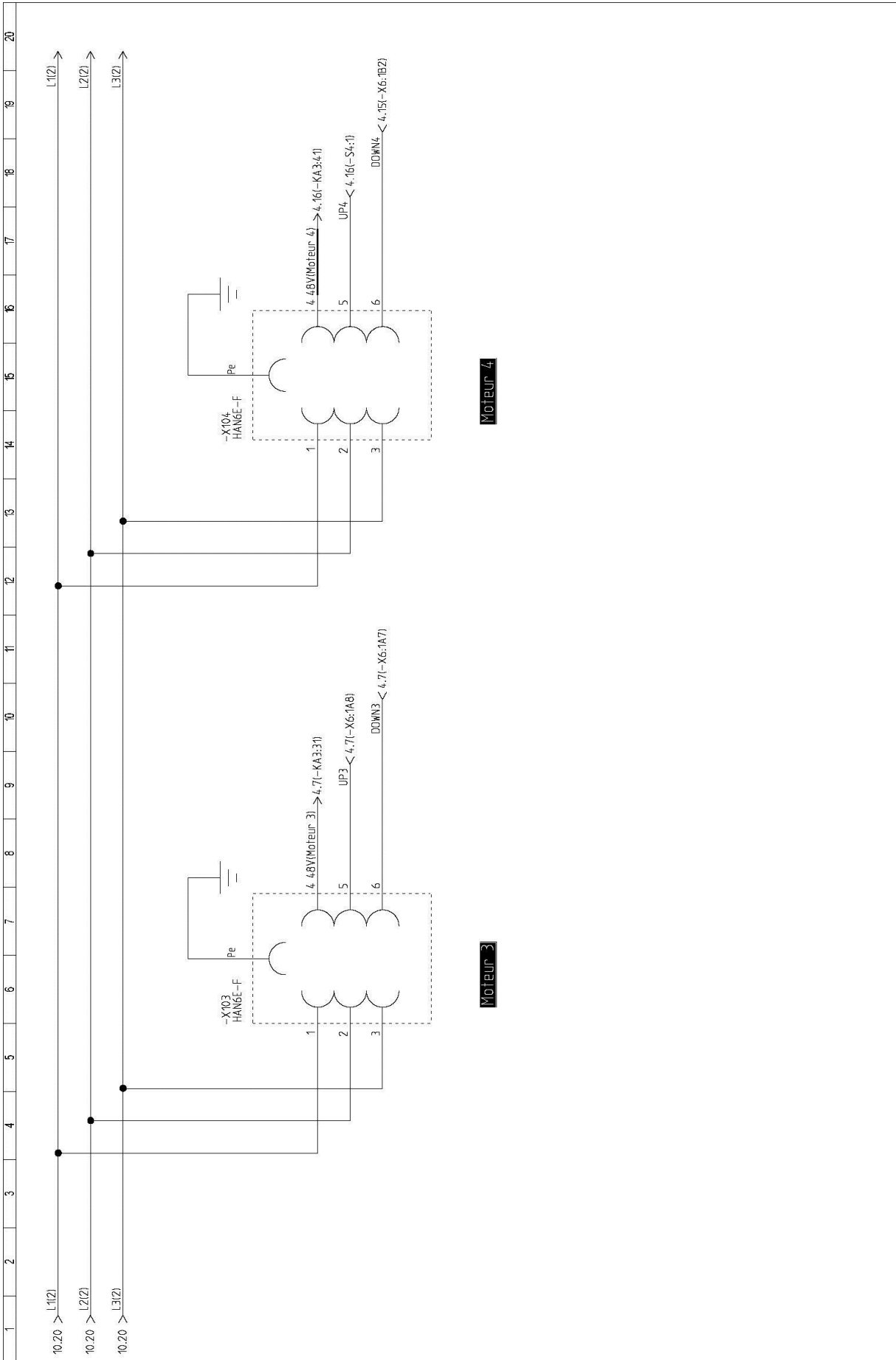

Moteur 4

Moteur 3

Verlinde		R12SRB		FOUO	
Dossier n° :		Schéma de puissance Moteur 3-4		11 / 15	
1	14/02/2014	Creation	MODE/CA/VEA	VER	R. HENRIEVE, S.A.

VERLINDE reserves the right to alter or amend specifications of its products without notice

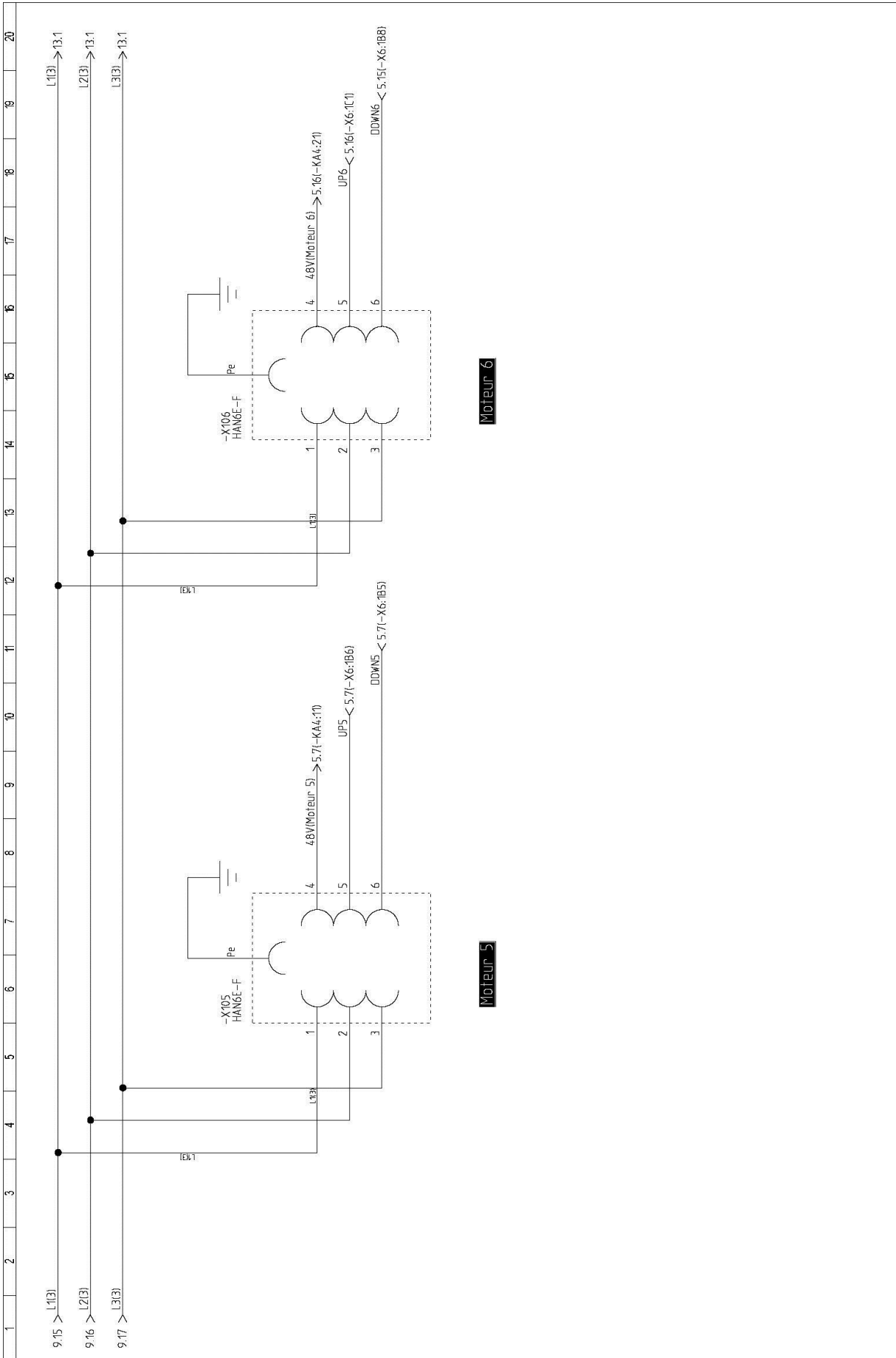

Moteur 6

Moteur 5

		Verlinde		R12SRB		FOLD 12 / 15
				Schéma de puissance Moteur 5-6		
		Dossier n° :				
1	94/02/274	Credition	MODIFICATION	VER		
PCCE	32'E					

VERLINDE se réserve le droit de modifier sans préavis les caractéristiques de son matériel.
VERLINDE reserves the right to alter or amend specifications of its products without notice

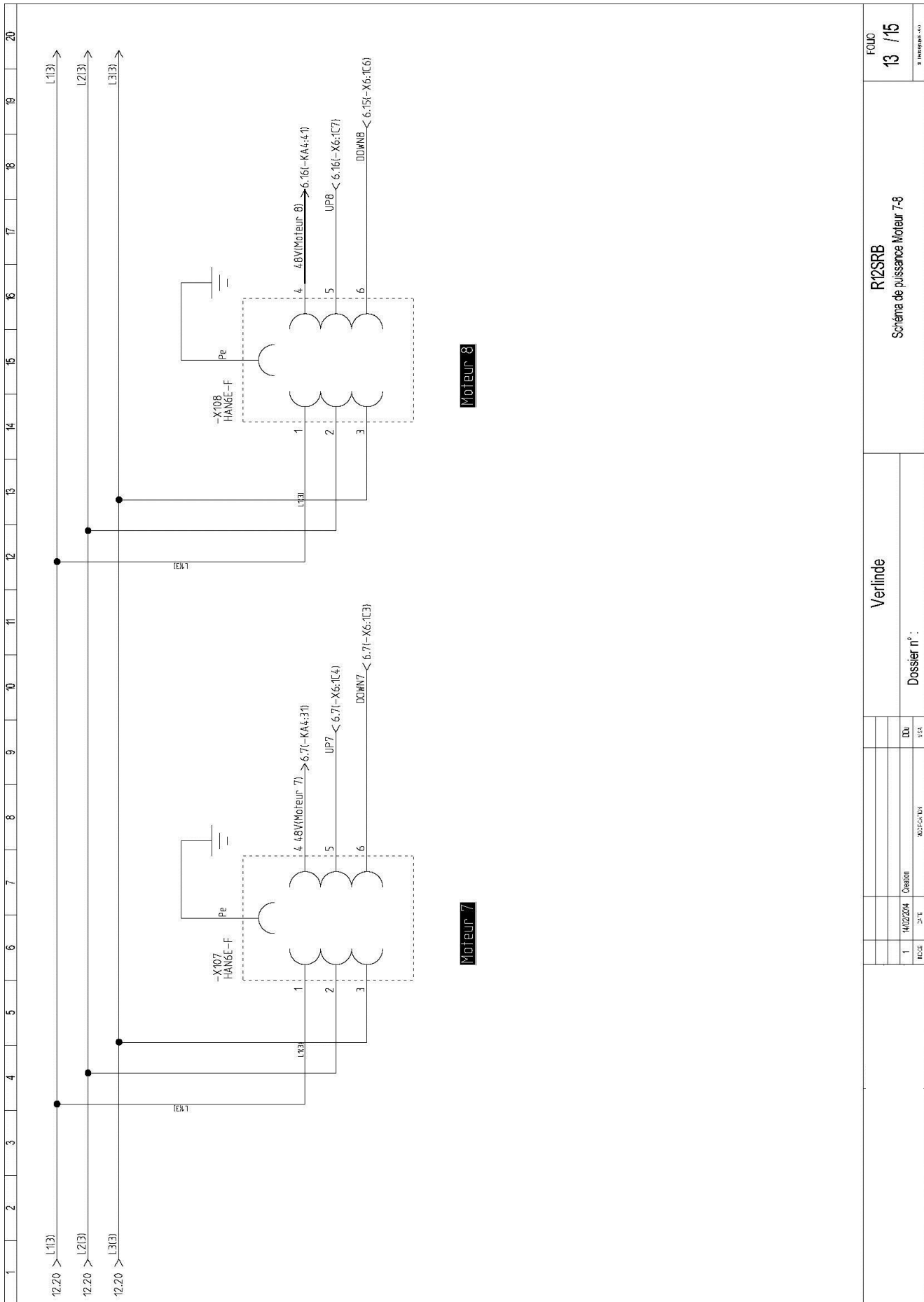

Verilinde		R12SRB		FOUO	
		Schéma de puissance Moteur 7-8		13 / 15	
Dossier n°:		R12SRB		R12SRB	
Date:		14/02/2014		13 / 15	
Version:		0052047V1		R12SRB	

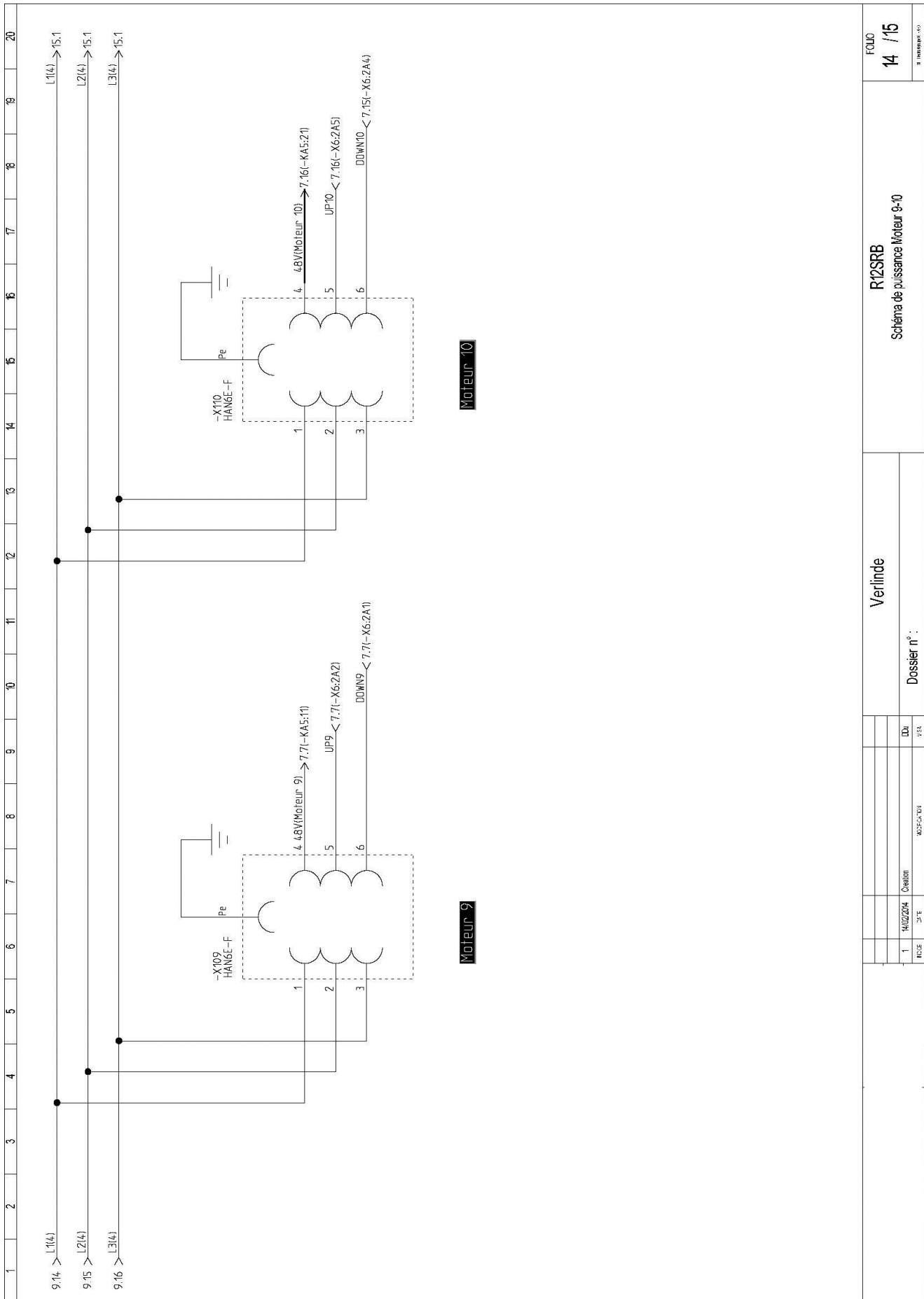

VERILINDE reserves the right to alter or amend specifications of its products without notice

Verilinde		R1ZSRB		FOUO	
		Schéma de puissance Moteur 9-10		14 / 15	
Dossier n°:		R1ZSRB		3	
1		14/02/2014		01/01/2014	
R1ZSRB		3:FE		3:ES	

Example of use

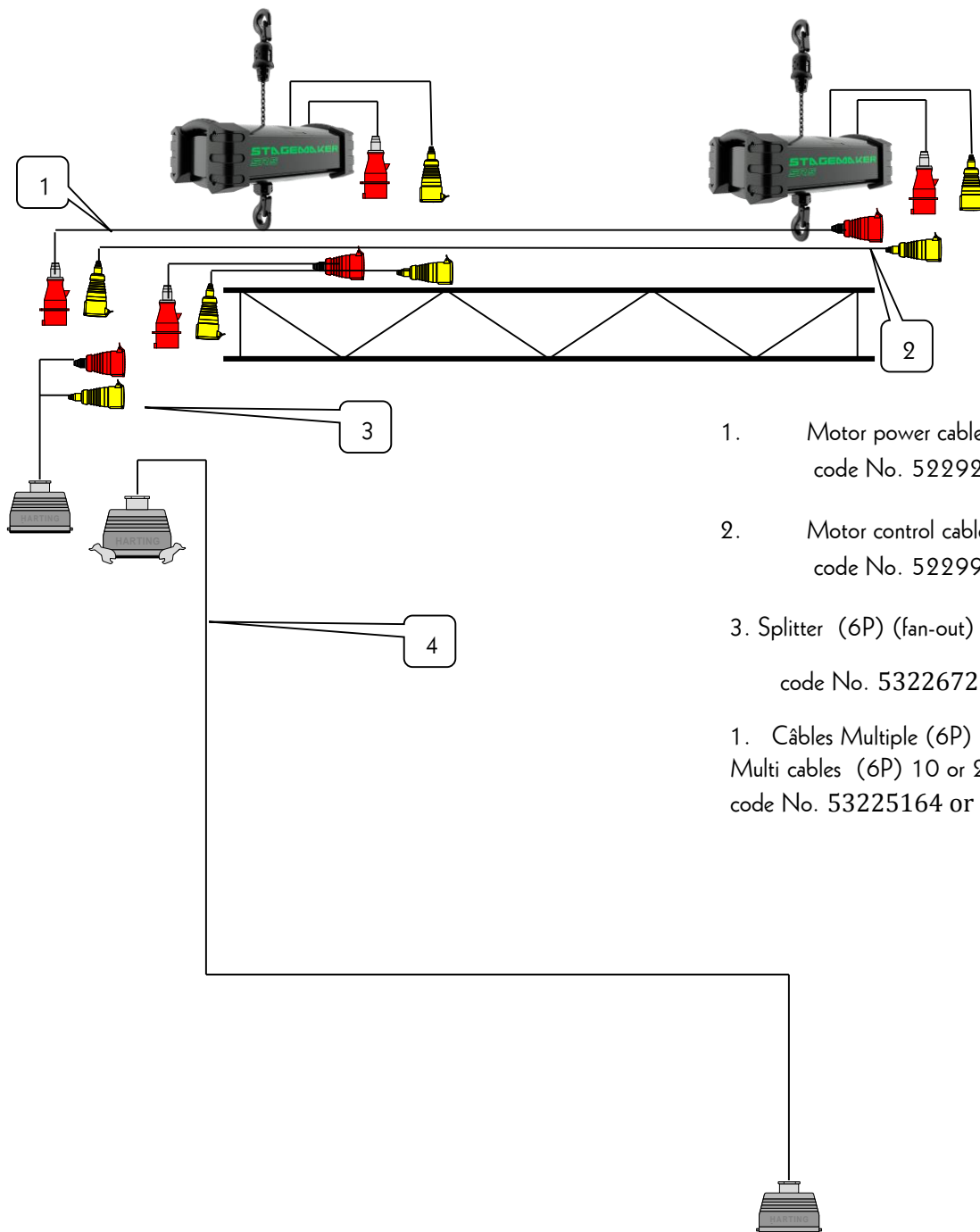

1. Motor power cables 10 or 20 M:
code No. 52292663 ou / or 52292664
2. Motor control cables 10 or 20 M:
code No. 52299853 ou / or 52299854
3. Splitter (6P) (fan-out) => Red + Yellow P17
code No. 53226725
1. Câbles Multiple (6P) 10 ou 20 M:
Multi cables (6P) 10 or 20 M:
code No. 53225164 or 53225171

Controller R4SRB & R8SRB



Power input
Alimentation

Example of use 4 & 8 channels

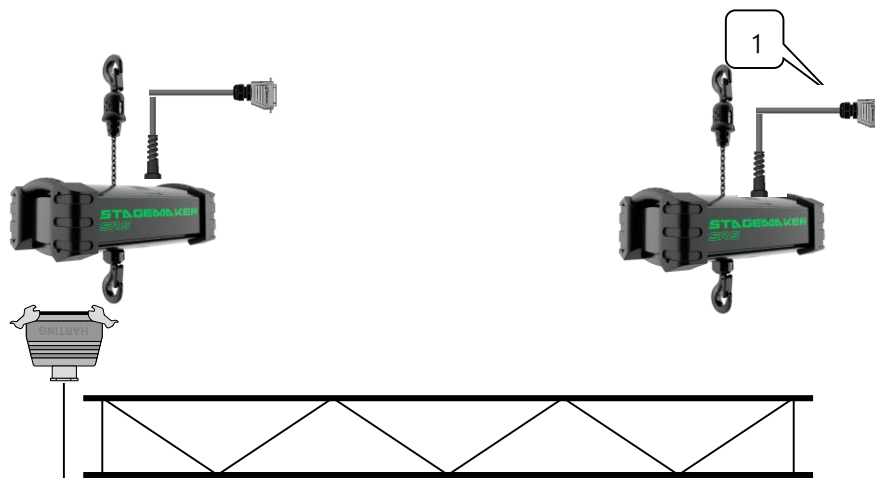

1. Option Connection cable 0,5m with Harting 6p (code : 53163135)
Instead of P17 red + Yellow
2. Câbles Multiple (6P) 10 ou 20 M:
Multi cables (6P) 10 or 20 M:
code No. 53225164 or 53225171



Controller R4SRB & R8SRB



**Power input
Alimentation**

Example of use 4 & 8 channels

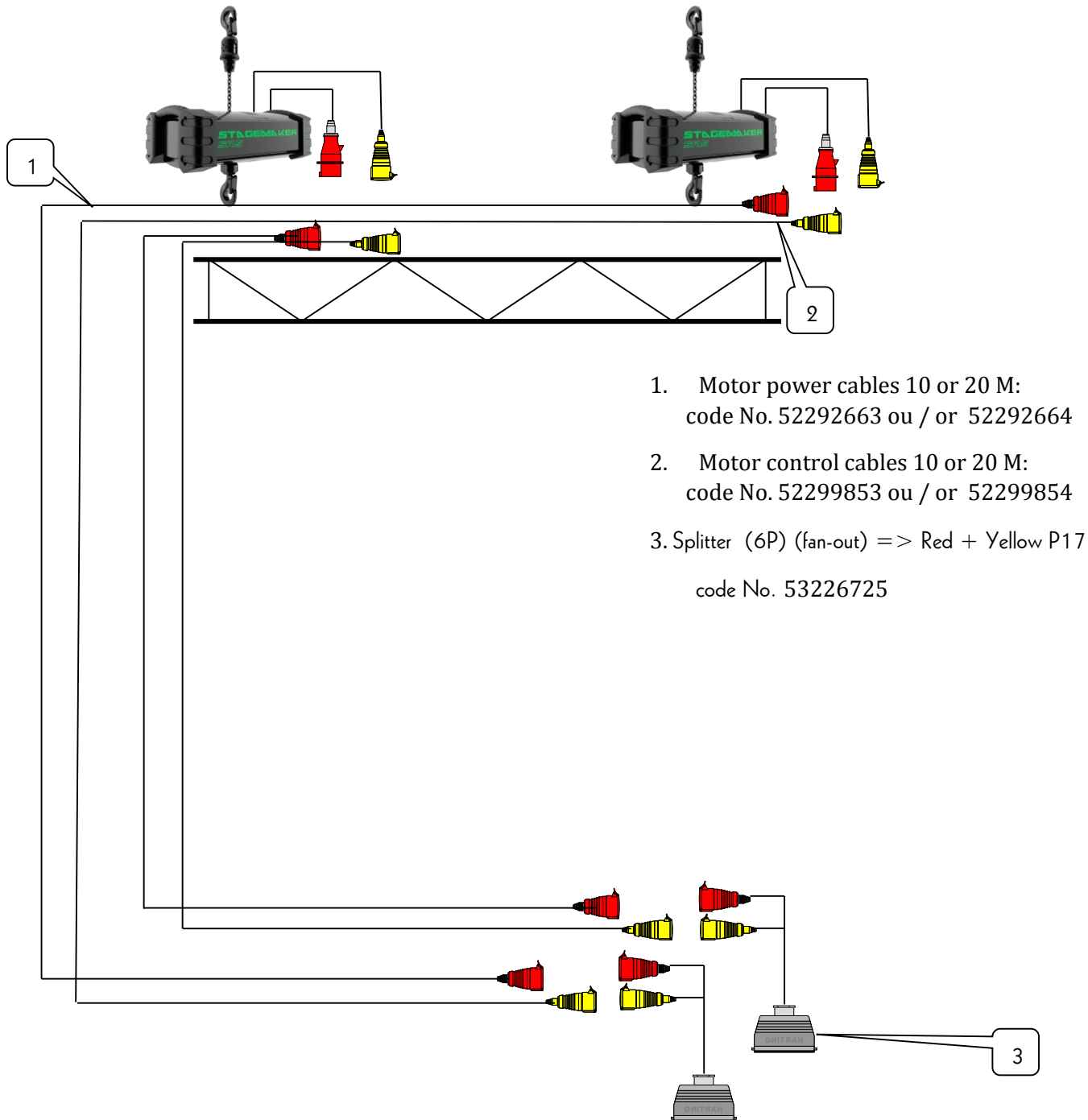

1. Motor power cables 10 or 20 M:
code No. 52292663 ou / or 52292664
2. Motor control cables 10 or 20 M:
code No. 52299853 ou / or 52299854
3. Splitter (6P) (fan-out) => Red + Yellow P17
code No. 53226725

Controller R4SRB & R8SRB



Power input
Alimentation

Example of use 12 channels

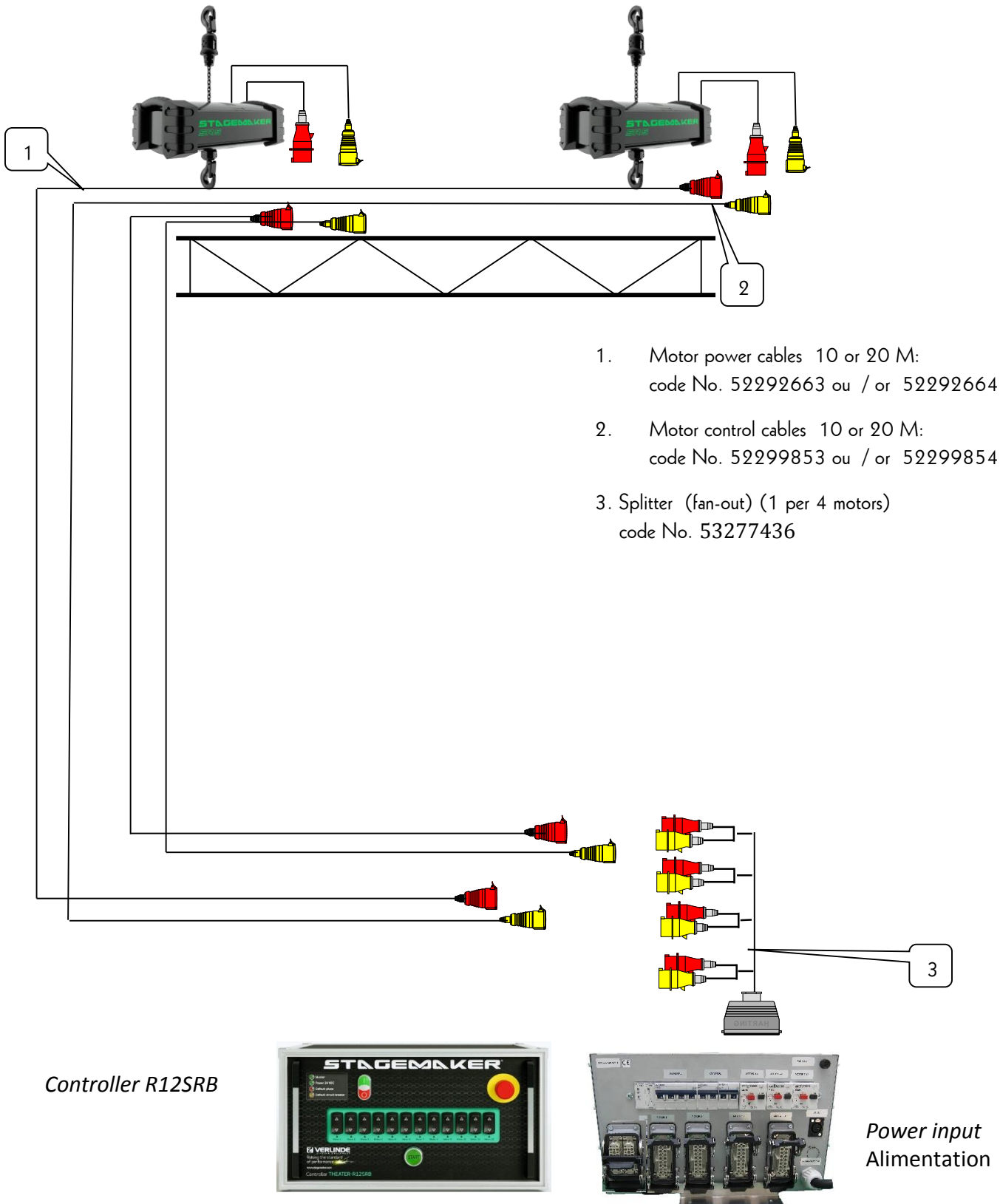

SPARE PARTS

Repère	Qte	Désignation	Référence
AU	1	Arret d'urgence à traction	M22-PV
AU	1	Support de fixation 3 éléments	M22-A
AU	1	Contact NF	M22-K01
AU	1	Plaque arrêt d'urgence 4 langues diam, 60	M22-XBK1
F1	1	Porte fusible 5x20	0031.1081
F1	1	Fusible 5x20 1,6AT	3403.0168
HL3-HL4	2	Led 5mm 20mA Verte (sous 24vac)	LTL4233
HL1	1	Led 5mm 20mA Rouge (sous 48vac)	LTL4223
HL2	1	Led 5mm 20mA Orange (sous 48vac)	LTL4253
H1-H4	4	Support de led noir 5mm	A104800AAC
KA1	1	Relais miniature 2 RT 8A 48Vac	40.52.8.048.0000
KA1	1	Support de relais 2RT avec etrier de maintien	788-103
KA2-3-4-5	4	Relais 4RT 24Vac avec Led	858-154
KA2-3-4-5	4	Support de relais 4RT	858-100
KA2-3-4-5	4	Etrier de maintien 4RT	858-110
KA2-3-4-5	6	Cavalier de pontage	858-402
KM1-2	2	Contacteur 3P 30A 1NF 48Vac	KNL30-00-E7
	2	Suppresseur d'arc ARC 48-250Vac	RC2
KM1-2	2	Bloc de contact auxiliaire 1NO+1NF	NDL2-11
MPH1	1	Contrôleur de manque de phase	IK9169
MPH2	1	Contrôleur de sens de rotation	IK9179
Q1	1	Disjoncteur divisionnaire 4PP 32A courbeD 10kA	D32T4
Q2	1	Disjoncteur divisionnaire 2PP 2A courbeD 10kA	D2T2
Q3	1	Disjoncteur divisionnaire 2PP 4A courbeC 6kA	C4T2
Q4-Q5-Q6	3	Disjoncteur moteur 16..20A(9kW)	MS25-20
Q4-Q5-Q6	1	Barette de montage 3 disjoncteurs tri	SB.D03
Q4-Q5-Q6	1	Bornier d'alimentation	SB.DE1
R1-R2	2	Resistance 4,7kohm 1/4W	SFR2500004701F
R3-R4	2	Resistance 2,2kohm 1/4W	SFR2500002201F
S1-S12	12	Interrupteur 3 position leds rouge et verte 24V	KR49JAXJKG22N09xx10
Start	1	Bouton poussoir diam 22 sans etiquette	M22-D-X
Start	1	Support de fixation 3 éléments	M22-A
Start	1	Contact NO	M22-K10
Start	1	Etiquette verte texte "Start"	M22-XD-G-GB1
T1	1	Transformateur mono 160VA-230/400V-2x24V	S03Q21LV00

Repère	Qte	Désignation	Référence
X1	1	Fiche P17 3P+N+T 32A 415V	S52SL30
X2	1	Embase XLR femelle 4 pts	NC4FP1BAG
X3 option	1	Embase XLR femelle 3 pts	NC3FP1BAG
X3 option	1	Fiche XLR mâle 3 pts	NC3MXX-BAG
X103-104-105	12	Embase à verrou HAN6E	CHI06L
X103-104-105	12	Corps isolant femelle HE6	CSEF06
X6	1	Embase à verrou HAN50	CHI50
X6	2	Corps isolant femelle HD25	CDF25
X6	50	Contact femelle à sertir 1mm ²	CDFA1,0
	1	Tiroir 9U commande palans	R9U/CP-R
	1	Capot rack commande palans	R9U/CP-CAP
	1	Face avant rack 9U R12 SRB sécable	FAV-9U-R12SRB-V1-SECABLE
	1	Face arriere 9U R12 SRB sécable	FAR-9U-12SRB-V1-SECABLE
	1	Serigraphie mutli couleur	R12SRB_V1
	1,35	Câble 5G4	H07RNF-5G4
	2	Entretoise acier zingué M6M/F L:60	304-6603-411-52
	1	Presse-étoupe PG21	1561-90-021
	1	Ecrou presse-étoupe PG21	1561-92-021
	2	Poignée 6U	61-1306-00
	12	Equerre de blocage	249-1170
	26	Borne à lames 3 pts/2,5 gris	2002-6301
	7	Borne à lames 3 pts/2,5 vert/jaune	2002-6307
	4	Flasque pour borne à lames 3 pts/2,5	2002-6391
	10	Pont 2 pts pour borne à lames 3 pts/2,5	2002-402
	1,095	3 x Rail DIN TS35x15 365mm	BIZ200210
	0,71	2 x Rail DIN TS35x15 355mm	BIZ200210
	0,21	1 x Rail DIN TS35x15 210mm	BIZ200210
	0,74	4 x L=370mm Goulotte de câblage à dents sécables 25x60	21159
	0,62	2 x L=310mm Goulotte de câblage à dents sécables 25x60	
	1	Lot de Visserie et Fils	
	1	Equerre de maintien en Clip Top (option)	